

Site Supervisor Controller

Quick Setup Guide

The Site Supervisor is a system that combines energy management with the ability to monitor various facility systems and provide alerts when there are issues that need attention. This system provides HVAC control, Refrigeration System Monitoring and Control, as well as Lighting Control. In addition, the Site Supervisor can monitor and report energy consumption and take action to reduce the energy demand during peak periods. This can have a direct impact on utility bills by reducing total energy costs. Site Supervisor ensures that the HVAC and lighting systems are on and off at the appropriate times. This ability to monitor store conditions can potentially minimize energy consumption.

For a copy of the full Site Supervisor Guide (P/N 026-1800), go to <http://www.emersonclimate.com/qrcode006> to download or contact Emerson Retail Solutions Customer Service at 770-425-2724.

Crossover Cable Instructions

Your new Site Supervisor is preset with a default IP Network Subnet Mask and Network Gateway. To connect to your Local Area Network, it will be necessary to change these default settings. Follow these steps to connect your laptop to the Site Supervisor and configure your network connection:

Connect your laptop to the Site Supervisor's Ethernet port ETH0 with a CAT5 crossover cable.

1. Under **Control Panel - Network and Sharing Center** select **Change Adapter Settings**.
2. Select the **Local Area Connection** port being used.
3. Select **Properties**.

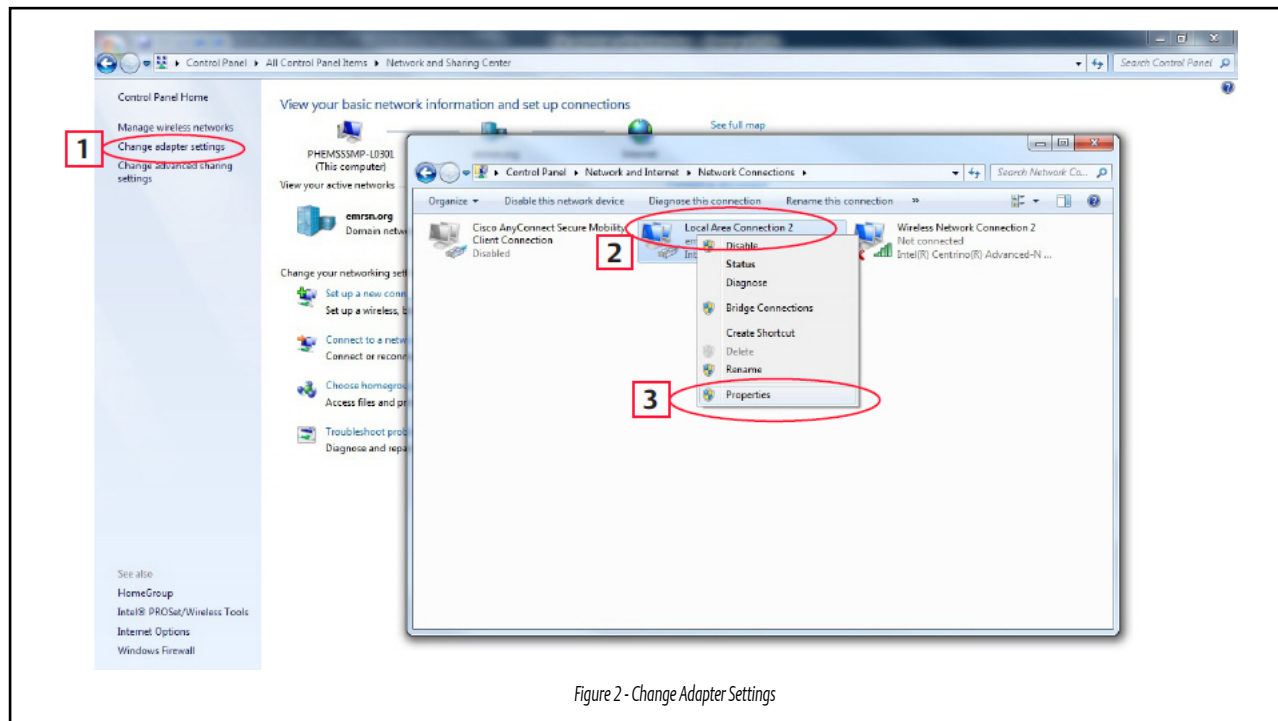

4. Highlight the section **Internet Protocol Version 4 (TCP/IPv4)** and click **Properties**.

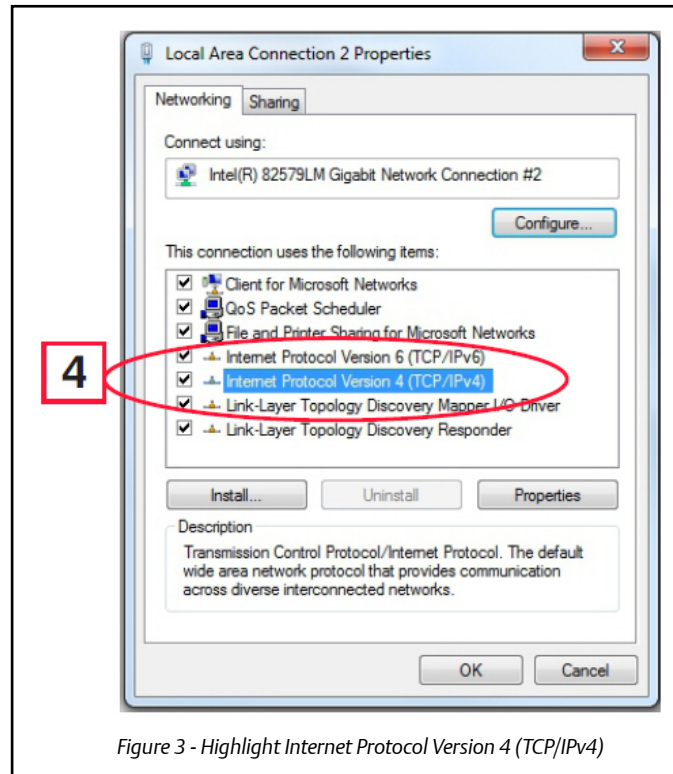

Figure 3 - Highlight Internet Protocol Version 4 (TCP/IPv4)

5. Click the Alternate Configuration tab and select Use the following IP address: and enter the determined IP address and the Subnet mask of the PC being used on the Local Area Network or direct connection and click OK.

Note: Depending on the PC used, the operating system might need to be restarted for the IP address to take place. For an "out of the box" Site Supervisor, its IP address is 192.168.0.250, and use 192.168.0.251/255.255.255.0 for direct connections with a PC.

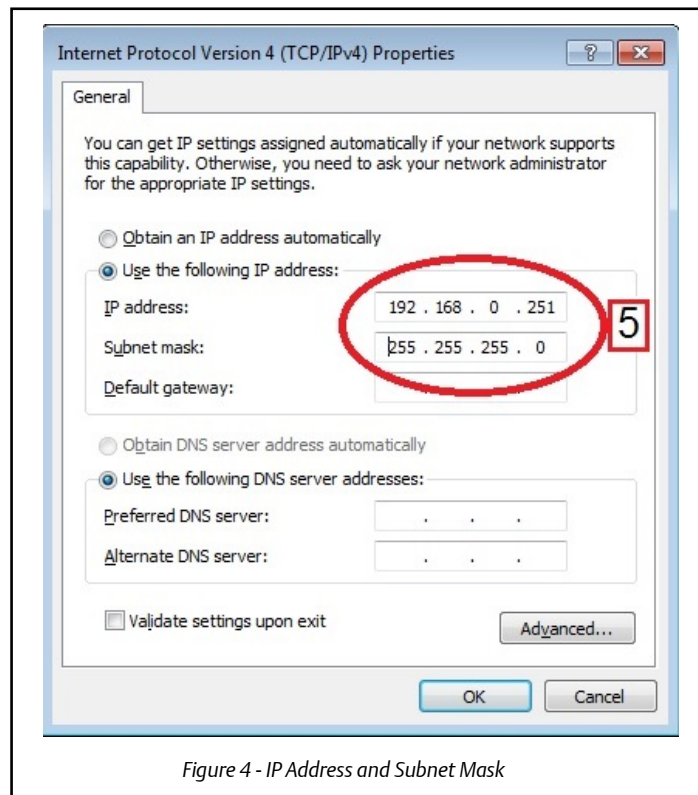

Figure 4 - IP Address and Subnet Mask

- Connect the TCP/IP cable to the Site Supervisor and to the laptop. The connection status light should be illuminated solid and the communications light should be flashing. Open an Internet browser and in the address bar, enter **http://** followed by the IP address assigned to the Site Supervisor. Then press Enter.

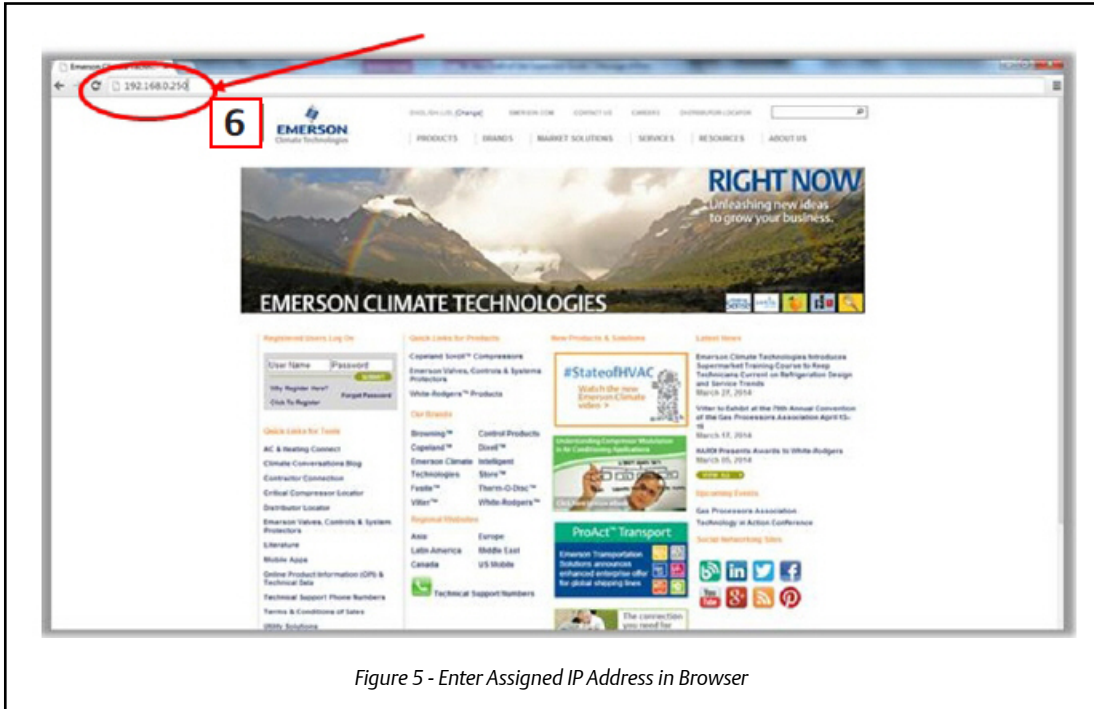

Figure 5 - Enter Assigned IP Address in Browser

Logging Into the Site Supervisor Controller

When the Site Supervisor is powered up for the first time, the first screen displayed after initialization is the Home screen. The default Username is **user** and the default Password is **pass**. Depending on your permission settings, once logged in, the Username and Password can be changed by clicking the Main Menu icon in the upper left corner and selecting **Manage Users**.

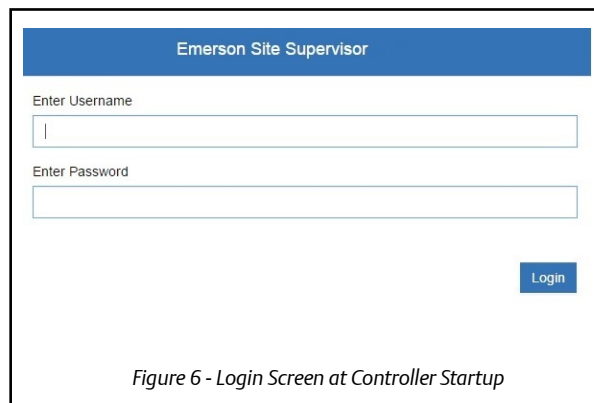

Figure 6 - Login Screen at Controller Startup

Setup Wizard

If your unit has been received directly from the Emerson factory, the Setup Wizard will open and take you through the following setup screens:

Localization Screen

The screenshot shows the 'Localization' screen in a 'Setup Wizard'. At the top, there is a blue header with a back arrow and the text 'Setup Wizard'. Below the header, the title 'Localization' is displayed. The main content area is divided into several sections:

- Type:** A dropdown menu set to 'System'.
- Language:** A dropdown menu set to 'English (United States)'.
- Date: Format:** Two radio buttons: 'M-D-YR' (selected) and 'D-M-YR'.
- Time: Format:** Two radio buttons: '12-hr' (selected) and '24-hr'.
- Select Engineering Units:** A section with multiple rows of radio buttons for different units:
 - Temperature: °F (selected) and °C.
 - Light: fc (selected) and lux.
 - Enthalpy: btu/Lb (selected) and kJ/kg.
 - Elec Current: mA and A.
 - Energy: Wh and kWh.
 - Power: W and kW.
 - Weight: lbs (selected) and kg.
- Delimiters:** Two dropdown menus: 'fwd-slashes' and 'colons'.
- Engineering Units (Right Column):** A series of dropdown menus for specific units:
 - Air Pressure: PSI
 - Gas Volume: Ccf
 - Gas Rate: Ccfh
 - Air Velocity: feet/min
 - Liquid Volume: Gal(US)
 - Liquid Rate: Gal(US)/Min
 - Temp Rate Change: °F/hr

Figure 7 - Localization Screen

Set the Site Supervisor's localization data such as language, date and time formats, and engineering units from the Localization screen.

Language: The default for the language selection is American English (United States). The system stores a setting for the preferred system language (internal language code). The default language is used when no user is currently logged into the Supervisor or when the currently active preferred language does not have a translation for a given label, prompt, or display text.

Date: The Date format can be set to either Day, Month, and full Year (D-M-YR) or Month-Day and full Year (M-D-YR) format. The day, month, and year values are separated by either a forward slash or a dash line depending on user selection.

The Date Format can be changed based on user preference and saved to user profiles. On initial Supervisor startup, the Date format defaults to the format of the language selected. For example, en-US will default to D-M-YR and all others will default to M-D-YR.

Time: The Time format can be set to either a 12-hour (12-hr) format or 24-hour (24-hr) format. The hour, minute, and second values are separated by either a colon or a period depending on user selection.

The Time format can be changed based on user preference and saved to user profiles. On initial Supervisor startup, the Time format defaults to the format of the language selected.

Date and Time delimiters default to forward slashes and colons.

Engineering Units: The default engineering units are based on the assigned units for the chosen preferred language. Users can choose or change their preferred set of engineering units and save them to their user profiles.

The default engineering units are based on the International System of Units (SI System) format.

Set the system language type in the **Language** drop-down menu. Click the right arrow > to save and proceed to the System Values screen.

System Values Screen

From the System Values screen, name the unit by entering it in the **Site Name** field. The Confirmation window will slide open. Click **OK**. Then click the right arrow > to proceed to the Network Settings Screen.

The screenshot shows the 'System Values' screen within a 'Setup Wizard'. The top bar is blue with a back arrow and 'Setup Wizard' text, and a right arrow. Below the bar, the title 'System Values' is displayed. The main content area is divided into three sections:

- GENERAL SETUP PARAMETERS:** Includes fields for 'Debug Log' (with a 'DISABLE' toggle), 'Site Name', 'Site Phone', 'Controller ID', 'NTP Enabled' (with a 'DISABLE' toggle), 'System Time' (09/29/2015 05:30:17 PM), and 'Time Zone' (set to '(GMT +00:00) Coordinated Universal Time - UTC (UTC)').
- WEB SERVER SETUP:** Includes fields for 'Web Port' (80), 'Secure Web Port' (443), 'E-mail address' (SiteSupervisor@emerson.com), and 'SMS address'.
- UI SETUP:** Includes dropdown menus for 'Home Screen' (Site Summary) and 'Floor Plan Home Screen'.

Figure 8 - System Values Screen

Network Settings Screen

Configure the settings on the Internet TCP/IP screen such as host name, text, and email settings. If you have Internet access, enter the **IP Subnet Mask** and **Default Gateway** settings (see your IT Administrator). If connecting directly to a laptop, use the Default IP and leave the **DHCP** set to **Disable**. For text messaging (without a GPRS), enable the SMS setting and use the SMTP address (see your IT Administrator).

The screenshot shows the 'Network Settings' screen. The top bar is blue with a menu icon and 'Network Settings' text. The main content area is divided into three sections:

- INTERNET (TCP/IP):** Includes fields for 'Domain Name', 'ETH 0 DHCP Enabled' (with a 'DISABLE' toggle), 'ETH 0 IP Address' (10.212.238.49), 'ETH 0 Subnet Mask' (255.255.240.0), 'ETH 0 Default Gateway' (10.212.224.1), 'DNS Server 1' (8.8.8.8), 'DNS Server 2' (8.8.4.4), 'ETH 0 MAC Address' (00:0A:F6:81:E4:E8), 'ETH 1 IP Address' (192.168.1.250), 'ETH 1 Subnet Mask' (255.255.255.0), and 'ETH 1 MAC Address' (00:0A:F6:81:E4:E9).
- E-MAIL(SMTP):** Includes a field for 'SMTP enabled' (with a 'DISABLE' toggle).
- TEXT MESSAGING(SMS):** Includes a field for 'SMS enabled' (with a 'DISABLE' toggle).

Figure 9 - Network Settings

Note to record these settings so you may refer to them later. The Site Supervisor may be configured to communicate across an Ethernet computer network using TCP/IP protocol. To enable Ethernet communication, you will need to enter IP address information for the controller in the Internet TCP/IP screen. The Internet Values screen allows you to change, update, or view settings for Internet (TCP/IP) networks connected to the Site Supervisor. Click the arrow > to save and finish the Setup Wizard and go to the Home screen.

Default Values Are:

Address: 10.212.238.49

Subnet Mask: 255.255.240.0

Default Gateway: 10.212.224.1

DNS Server 1: 8.8.8.8

DNS Server 2: 8.8.4.4

Basic Navigation

For every Site Supervisor screen, the Main Menu, Home, Back Arrow, Control Inventory, and Schedules/Events icons appear at the first row of top of the screen. A screen title also appears at the top left of the screen.

Basic Screen Parts and Elements:

- **Main Display** - this is the main section of the screen, which contains and displays the content of the chosen selection such as reports, device information, configuration settings, and more.
- **Menus and Submenus** - these can be viewed on the Main Menu Panel. The Menus and Submenus are grouped into different categories. Each menu selection can have several submenus. When you click on a lowest submenu level, the screen of the chosen selection is displayed.

Note: When some screen information and contents are clicked, more or related information can be displayed or additional screens accessed.

Icons and Buttons Appearing on the Home Screen:







Icon/Button	Function
	Main Menu (three horizontal line) Located at the top left-hand side of the screen. When Main Menu button is clicked, main menu panel will slide open containing the menus and submenus of the controller.
	Home Opens the main menu panel when clicked. The main menu panel contains menus and submenus of the controller.
	Back Arrow The Back button will return you to the previous screen.
	Active Alarms When the Active Alarm icon is clicked, the screen will display the current active alarms.
	Filter Clicking the Filter icon opens the Filter Alarms screen which allows you to choose or filter the type of alarm you want to see on your Active Alarms screen. Located at the top right-hand side of the screen
	Screen Drop-down Menu The screen drop-down menu is activated when the current screen is active/online. This screen menu contains additional screen options. Note that some options may be different from other screen options.
	Control Inventory Click to manage the system-wide inventory of applications. Edit, delete, and add applications from this screen.

Table 1 - Screen Icons and Buttons









	Schedules and Events	Click to add and edit schedules and events.
	Online help	Displays help for the current screen you are viewing.
	Refrigeration	Displays on Home screen and application screens. Shows all applications in the controller that are categorized under Refrigeration.
	HVAC	Displays on Home screen and application screens. Shows all applications in the controller that are categorized under HVAC. Click to go to the application.
	Lighting	Displays on Home screen and application screens. Shows all applications in the controller that are categorized under Lighting. Click to go to the application.
	Energy	Displays on Home screen and application screens. Shows all applications in the controller that are categorized under Energy. Click to go to the application.
	Other	Displays on Home screen and application screens. Shows all applications in the controller that are categorized under Other. Click to go to the application.
	System	Displays on Home screen and application screens. Shows all applications in the controller that are categorized under System. Click to go to the application.

Table 1 - Screen Icons and Buttons

LEDs

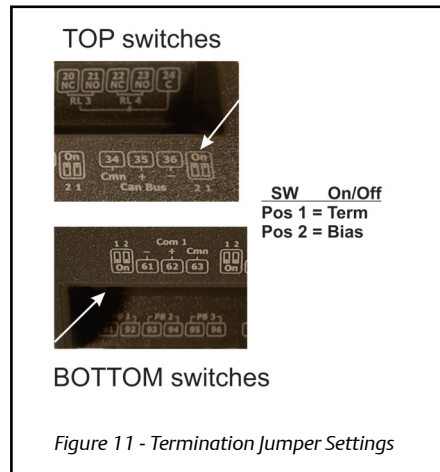

Figure 10 - LEDs

STATE	DESCRIPTION
Solid red	Starting up
Flashing red - 1 Hz	Loading OS/Application
Solid green	Running - Normal Status
Flashing red - 2 Hz	Failure to load

Table 2 - LED States and Descriptions

Termination Jumper Settings



UL Ratings

Type	Ratings	Terminal
Relay 1 (N.O. & N.C.)	5A, 125/240 VAC, General Purpose, 100K cycles; 4FLA/4LRA, 250VAC, Motor Load, 100K cycles;	J5-2, J5-3, J5-4 (Base Board)
Relay 2 (N.O. & N.C.)	5A, 125/240 VAC, General Purpose, 100K cycles; 4FLA/4LRA, 250VAC, Motor Load, 100K cycles;	J5-1, J5-2, J6-6 (Base Board)
Relay 3 (N.O. & N.C.)	5A, 125/240 VAC, General Purpose, 100K cycles; 4FLA/4LRA, 250VAC, Motor Load, 100K cycles;	J6-1, J6-4, J6-5 (Base Board)
Relay 4 (N.O. & N.C.)	5A, 125/240 VAC, General Purpose, 100K cycles; 4FLA/4LRA, 250VAC, Motor Load, 100K cycles;	J6-1, J6-2, J6-3 (Base Board)

Table 3 - UL Ratings

Housing Dimensions and Mounting

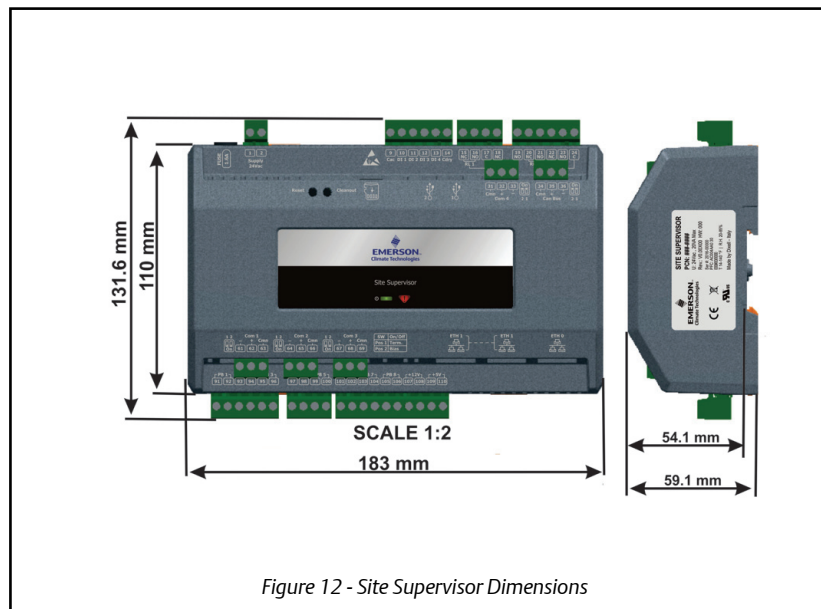

The Site Supervisor is DIN Rail mounting compatible. Snap the orange tabs on the back of the unit to the down position to fasten. If not using the DIN Rail mounting option, fasten to the mounting surface using the openings in the mounting tabs.

Technical Specifications

Operating Temperature	14°F to 140°F (-10°C to 60°C)
Relative Humidity	20-85% RH non-condensing
Enclosure Rating	UL 94 V-0
Dimensions	103.7 x 34.7mm
24 VAC	20VA required 24VAC/20VA
1 Can Bus	Expansion Module Connections
4 RS485 ports	MODBUS Com Ports 1, 2, 3, and 4
3 Ethernet ports	Ports 1, 1, 0
2 USB ports	1, 2
MicroSD	1
Analog Inputs	8
Digital Inputs	4
Relay Outputs	4

Table - 4 - Technical Specifications

Wiring Diagram

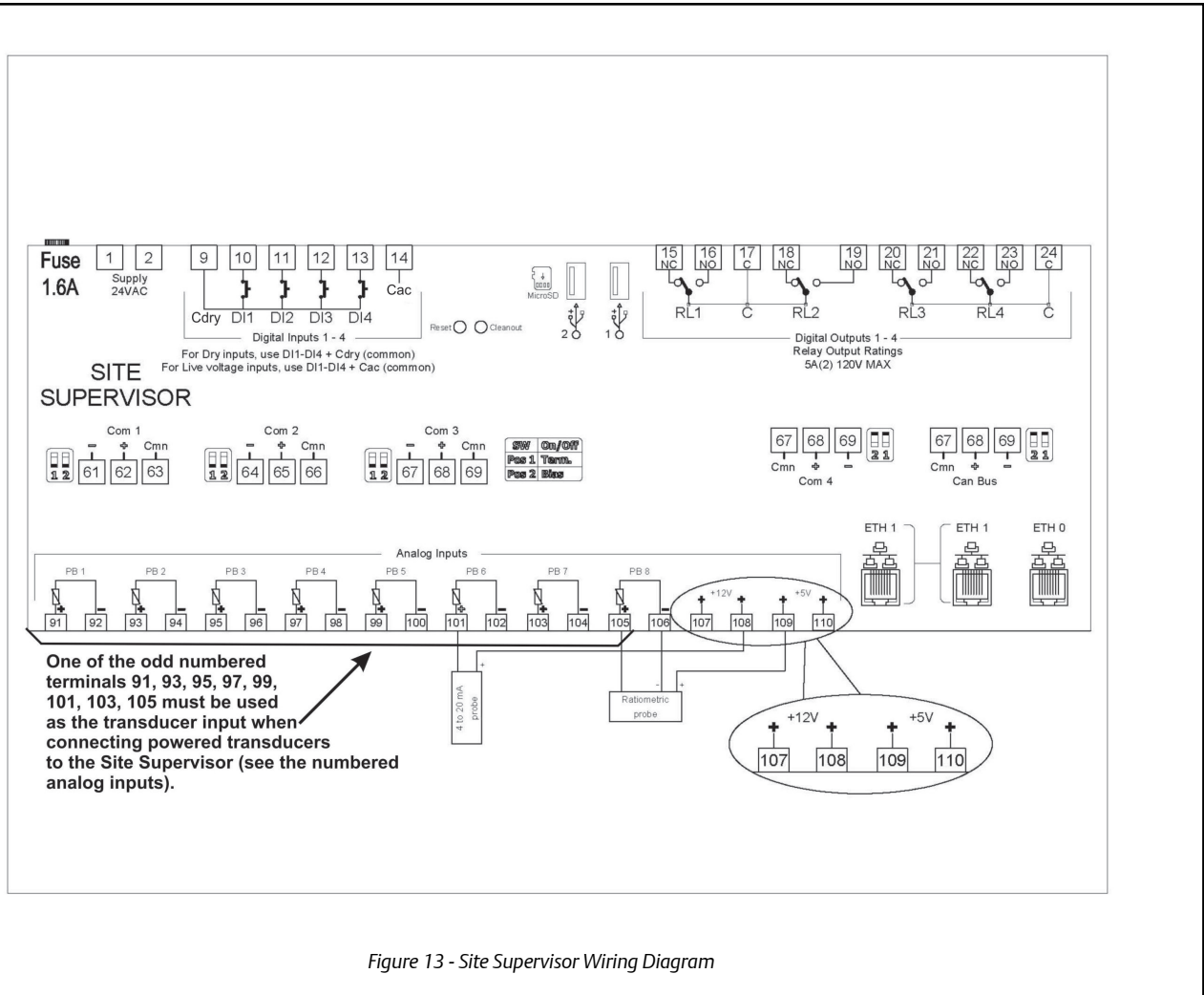

Figure 13 - Site Supervisor Wiring Diagram

Site Supervisor Wiring Guide Example

For more wiring information, refer to the latest Site Supervisor user manual (P/N 026-1800).

