

ZP16 to ZP44K3E and ZP14 to ZP61K5E R-410A 1.5 to 5 Ton Copeland Scroll™ Compressors





TABLE OF CONTENTS

<u>Section</u>	<u>Page</u>	<u>Section</u>	<u>Page</u>
Safety		System Tubing Stress	10
Safety Instructions.....	2	Three Phase Scroll Electrical Phasing.....	10
Safety Icon Explanation	2	Brief Power Interruptions.....	11
Instructions Pertaining to Risk of Electrical Shock, Fire, or Injury to Persons.....	3	Manifolding Tandem Compressors.....	11
Safety Statements.....	3	Tandem Applications	11
Introduction	4	Maximum Tilt Angles	11
Nomenclature.....	4	Application Tests	
Application Considerations		Application Summary.....	11
Internal Pressure Relief Valve.....	4	Continuous Floodback Test.....	12
Discharge Temperature Protection.....	4	Field Application Test	12
Heat Pump Protection	5	Assembly Line Procedures	
Discharge Line Thermostat	5	Installing the Compressor	12
Air-Conditioning Unit Protection	5	Assembly Line Brazing Procedure	13
High Pressure Cut-Out Switch	5	Tandem Assembly	13
Shut Down Device.....	5	Pressure Testing	13
Discharge Check Valve	6	Assembly Line System Charging Procedure.....	13
Motor Overload Protection	6	High Potential (AC Hipot) Testing.....	13
Operating Envelope	6	Final Run Test	14
Power Supply	6	Unbrazing System Components	14
Accumulators	6	Service Procedures	
Charge Compensators	6	Copeland Scroll Functional Check.....	14
Screens	7	Compressor Replacement After Motor Burn	15
Crankcase Heat-Single Phase	7	Start Up of a New or Replacement Compressor ..	15
Crankcase Heat-Three Phase.....	7	Tandem Service.....	15
Pump Down Cycle.....	7	Figures & Tables	
Minimum Run Time	7	Oil Dilution Chart	16
Reversing Valves	8	Accumulator Piping	17
Low Ambient Cut-Out.....	8	Time Delay Wiring.....	17
Oil Type	8	Compressor Electrical Connection.....	18
Contaminant Control	8	Discharge Thermostat	18
Long Line Sets/High Refrigerant Charge	8	Crankcase Heater	18
Discharge Mufflers	9	R410A Scroll Operating Envelope.....	19
Air-Conditioning System Suction Line		Scroll Suction Tube Brazing	20
Noise & Vibration	9	How a Scroll Works.....	21
Mounting Parts	9	Typical ZPK5 Tandem	22
Single Phase Starting Characteristics.....	9	Tilted Tandem.....	22
PTC Start Components	10	Field Application Test	23
Electrical Connections.....	10	Design Configurations.....	23
Deep Vacuum Operation	10	Compressor Accessories	24-25
Shell Temperature	10	Compressor Refrigerant Charge Limits.....	25
Suction & Discharge Fittings.....	10		





Safety Instructions

Copeland Scroll™ compressors are manufactured according to the latest U.S. and European Safety Standards. Particular emphasis has been placed on the user's safety. Safety icons are explained below and safety instructions applicable to the products in this bulletin are grouped on Page 3. These instructions should be retained throughout the lifetime of the compressor. **You are strongly advised to follow these safety instructions.**

Safety Icon Explanation

	DANGER indicates a hazardous situation which, if not avoided, will result in death or serious injury.
	WARNING indicates a hazardous situation which, if not avoided, could result in death or serious injury.
	CAUTION, used with the safety alert symbol, indicates a hazardous situation which, if not avoided, could result in minor or moderate injury.
	NOTICE is used to address practices not related to personal injury.
	CAUTION, without the safety alert symbol, is used to address practices not related to personal injury.

Instructions Pertaining to Risk of Electrical Shock, Fire, or Injury to Persons

	<p>ELECTRICAL SHOCK HAZARD</p> <ul style="list-style-type: none"> • Disconnect and lock out power before servicing. • Discharge all capacitors before servicing. • Use compressor with grounded system only. • Molded electrical plug must be used in all ZP*K5 applications. • Refer to original equipment wiring diagrams. • Electrical connections must be made by qualified electrical personnel. • Failure to follow these warnings could result in serious personal injury.
	<p>PRESSURIZED SYSTEM HAZARD</p> <ul style="list-style-type: none"> • System contains refrigerant and oil under pressure. • Remove refrigerant from both the high and low compressor side before removing compressor. • Use appropriate back up wrenches on rotalock fittings when servicing. • Never install a system and leave it unattended when it has no charge, a holding charge, or with the service valves closed without electrically locking out the system. • Use only approved refrigerants and refrigeration oils. • Personal safety equipment must be used. • Failure to follow these warnings could result in serious personal injury.
	<p>BURN HAZARD</p> <ul style="list-style-type: none"> • Do not touch the compressor until it has cooled down. • Ensure that materials and wiring do not touch high temperature areas of the compressor. • Use caution when brazing system components. • Personal safety equipment must be used. • Failure to follow these warnings could result in serious personal injury or property damage.
	<p>COMPRESSOR HANDLING</p> <ul style="list-style-type: none"> • Use the appropriate lifting devices to move compressors. • Personal safety equipment must be used. • Failure to follow these warnings could result in personal injury or property damage.

Safety Statements

- Refrigerant compressors must be employed only for their intended use.
- Only qualified and authorized HVAC or refrigeration personnel are permitted to install, commission and maintain this equipment.
- Electrical connections must be made by qualified electrical personnel.
- All valid standards and codes for installing, servicing, and maintaining electrical and refrigeration equipment must be observed.

Introduction

The ZP*K3E and ZP*K5E Copeland Scroll™ compressors include a wide range of capacities, electrical options, and features. Typical model numbers are ZP32K3E-PFV and ZP51K5E-PFV. This bulletin describes the operating characteristics, design features, and application requirements for these models.

For additional information, please refer to our Online Product Information, accessible from the Emerson Climate Technologies website at www.emersonclimate.com. Operating principles of the Copeland Scroll compressor are described in **Figure 9**.

The ZP*K3 scrolls are older models introduced in 1996. They were designed for 11+ SEER air conditioning and heat pump usage ranging in size from 15,500 to 44,300 Btu/hr (4.5 to 13.0 kW). These models include all of the standard 50 and 60 Hertz, single and three phase voltages.

The ZP*K5E is the newest R-410A scroll family designed for higher efficiency and lower sound. These compressors have features such as a Unitary Shutdown Device (USD) and a new thermal disc location for better high discharge temperature response. The ARI capacity for these models ranges from 14,500 to 61,000 Btu/hr (4.5 to 17.9 kW) with the same voltage offering as the ZP*K3E.

The models include a number of features outlined in the matrix below.

Nomenclature

The model numbers of the Copeland Scroll compressors include the approximate nominal 60 Hz capacity at standard operating conditions. An example would be the ZP23K3E-TFD, which has 23,400 Btu/hr (6.3kW) cooling capacity at the ARI high temperature air conditioning rating point when operated at 60 Hz. Note that the same compressor will have approximately 5/6 of this capacity or 19,000 Btu/hr (5.6kW) when operated at 50 Hz. Please refer to Online Product Information at www.emersonclimate.com for details.

Application Considerations

The following application guidelines should be considered in the design of a system using ZP*K3 and ZP*K5 scroll compressors. Some of this information is recommended, whereas other guidelines must be followed. The Application Engineering department will always welcome suggestions that will help improve these types of documents.

Internal Pressure Relief (IPR) Valve

The internal pressure relief valve is located between the high and low side of the compressor. It is designed to open when the discharge-to-suction pressure differential exceeds 550 to 625 psid (38-43 bar). When the valve opens, hot discharge gas is routed back into the area of the motor protector to cause a trip. During fan failure testing, system behavior and operating pressures will depend on the type of refrigerant metering device. Fixed orifice devices may flood the compressor with refrigerant, and thermostatic expansion devices will attempt to control superheat and result in higher compressor top cap temperatures. Fan failure testing or loss of air flow in both cooling and heating should be evaluated by the system designer to assure that the compressor and system are protected from abnormally high pressures.

Discharge Temperature Protection



Compressor top cap temperatures can be very hot. Care must be taken to ensure that wiring or other materials which could be damaged by these temperatures do not come into contact with these potentially hot areas.

The Therm-O-Disc™ or TOD is a temperature-sensitive snap disc device located between the high and low pressure side of the scroll or on the muffler plate. It is designed to open and route excessively hot discharge gas back to the motor protector when the internal discharge gas exceeds 290°F (144°C). During a situation such as loss of charge, the compressor

Model	Motor Frame Size*	Application		IPR	TOD	Quiet Shutdown	Discharge Check Valve	Motor Protector	Electrical Connections
		AC	HP						
ZP14-31K5	53	X	X	X	X	X	X	X	MP
ZP34-61K5	63	X	X	X	X	X	X	X	MP
ZP16-44K3	63	X	X	X	X	X	X	X	MP, QC

* Approximate Shell Diameter (e.g. 53 = 5.5", 63 = 6.5")

MP = Molded Plug, QC = 1/4" Quick Connect

will be protected for some time while it trips the protector. However, as refrigerant leaks out, the mass flow and the amperage draw are reduced and the scrolls will start to overheat. A low pressure control is recommended for loss of charge protection for the highest level of system protection. The low pressure cut-out can provide protection against indoor blower failure in cooling, outdoor fan failure in heating, closed liquid or suction line service valves, or a blocked liquid line screen, filter, orifice, or TXV. All of these can starve the compressor of refrigerant and result in compressor failure. The low pressure cut-out should have a manual reset feature for the highest level of system protection. If a compressor is allowed to cycle after a fault is detected, there is a high probability that the compressor will be damaged and the system contaminated with debris from the failed compressor and decomposed oil. If current monitoring of the compressor is available, the system controller can take advantage of the compressor TOD and internal protector operation. The controller can lock out the compressor if current draw is not coincident with the contactor energizing, implying that the compressor has shut off on its internal protector. This will prevent unnecessary compressor cycling on a fault condition until corrective action can be taken.

Heat Pump Protection

A low pressure control is highly recommended for loss of charge protection and other system fault conditions that may result in very low evaporating temperatures. Even though these compressors have internal discharge temperature protection, loss of system charge will result in overheating and recycling of the motor overload protector. Prolonged operation in this manner could result in oil pump out and eventual bearing failure. A cut out setting no lower than 20 psig (1.4 bar) is recommended.

Operation near -25°F (-32°C) saturated suction temperature is clearly outside the approved operating envelope shown in **Figure 7**. However, heat pumps in some geographical areas have to operate in this range because of the low ambient temperatures. This is acceptable as long as the condensing temperature is not above 90°F (32°C) and the resulting discharge temperature is below 275°F (135°C). Some liquid floodback to the compressor under these conditions can help keep the discharge temperature under control.

Discharge Line Thermostat

Some systems, such as air-to-air heat pumps, may not work with the above low pressure control arrangement.

A discharge line thermostat set to shut the compressor off before the discharge temperature exceeds 260°F (125°C) may have to be used to achieve the same protection. Mount the discharge thermostat as close as possible to the compressor discharge fitting and insulate well. See **Figure 5** and **Table 4** for recommended Emerson Climate Technologies part numbers.

Air Conditioning Unit Protection

Air-conditioning-only units can be protected against high discharge temperatures through a low pressure control in the suction line. Testing has shown that a cut out setting of not lower than 55 psig (3.8 bar) will adequately protect the compressor against overheating from the aforementioned loss of charge, blower failure in a TXV system, etc. A higher level of protection is achieved if the low pressure control is set to cut out around 95 psig (6.7 bar) to prevent evaporator coil icing. The cut in setting can be as high as 180 psig (12.5 bar) to prevent rapid recycling in case of refrigerant loss. If an electronic controller is used, the system can be locked out after repeated low pressure trips.

High Pressure Control

If a high pressure control is used with these compressors **the recommended maximum cut out setting is 650 psig (45 bar)**. The high pressure control should have a manual reset feature for the highest level of system protection. **It is not recommended to use the compressor to test the high pressure switch function during the assembly line test.**

Shut Down Device

All scrolls in this size range have one of several types of shutdown solutions that nearly eliminate shut down noise. Single phase ZP*K3 scrolls use a cam-type device that separates the scrolls when they are driven backwards as high-pressure gas equalizes from the high side of the compressor to the low side during shutdown. Three phase ZP*K3 scrolls use a fluid brake to mitigate reverse rotation sound after shutdown. The new ZP*K5 scrolls incorporate a scroll discharge port check valve that prevents high pressure gas trapped in the dome from returning through the scroll set after shutdown. All of these shut down solutions allow the scroll compressor to restart immediately even if the system is not equalized, eliminating the need for a time delay. Development testing should include a review of the shutdown sound for acceptability in a particular system. Please refer to the section on **Brief Power Interruption**.

Discharge Check Valve

A low mass, disk-type check valve in the discharge fitting of the compressor prevents the high side, high pressure discharge gas from flowing rapidly back through the compressor after shutdown. This check valve was not designed to be used with recycling pump down because it is not entirely leak-proof.

Motor Overload Protection

Conventional internal line break motor overload protection is provided. The overload protector opens the common connection of a single-phase motor and the center of the Y connection on three-phase motors. The three-phase overload protector provides primary single-phase protection. Both types of overload protectors react to current and motor winding temperature.

Operating Envelope

The ZP*K3 and ZP*K5 model families are approved for use with R-410A only. See **Figure 7** for the R-410A operating envelope. The envelope represents safe operating conditions with 20F° (11K) superheat in the return gas. The line marked “95F° max” is the limit of operation with a constant return gas temperature of 95°F (35°C). This illustrates that the warmer the return gas, the more limited the operating envelope will be as the external discharge temperature approaches 250-275°F (120-132°C) danger zone. Use of refrigerants other than R-410A voids the UL listing of these compressor models. R-410A may only be used with compressors tested and approved for this higher pressure refrigerant and that contain polyol ester (POE) oil. Compressors containing POE oil have an “E” in the seventh place of the model number, e.g. ZP31K5E-PFV.

Power Supply

All motors for the ZP compressors, whether single or three phase, with the exception of the “PFV” 208-230, 1Ø, 60 Hz motor, are designed to operate within a voltage range of +/-10% of the voltages shown on the nameplate. For example, a compressor with a nameplate voltage of 200-230 volts can start and operate within a range of 180-253 volts. Compressors with a “PFV” designated motor such as ZP24K5E-PFV, may only be operated in a range of 197-253 volts under maximum load conditions.

Accumulators

The use of accumulators is very dependent on the application. The Copeland Scroll compressor’s inherent ability to handle liquid refrigerant during occasional

operating flood back situations make the use of an accumulator unnecessary in standard designs such as condensing units. Applications such as heat pumps with orifice refrigerant control that allow large volumes of liquid refrigerant to flood back to the compressor during normal steady operation can dilute the oil to such an extent that bearings are inadequately lubricated, and wear will occur. In such a case an accumulator must be used to reduce flood back to a safe level that the compressor can handle. Heat pumps designed with a TXV to control refrigerant during heating may not require an accumulator if testing assures the system designer that there will be no flood back throughout the operating range. To test for flood back conditions and determine if the accumulator or TXV design is adequate, please see the section entitled **Application Tests**. The accumulator oil return orifice should be from .040 to .055 inches (1 – 1.4mm) in diameter depending on compressor size and compressor flood back results. A large-area protective screen no finer than 30x30 mesh (0.6mm openings) is required to protect this small orifice from plugging. Tests have shown that a small screen with a fine mesh can easily become plugged causing oil starvation to the compressor bearings. The size of the accumulator depends upon the operating range of the system and the amount of sub cooling and subsequent head pressure allowed by the refrigerant control. System modeling indicates that heat pumps that operate down to and below 0°F (-18°C) will require an accumulator that can hold around 70% to 75% of the system charge. Behavior of the accumulator and its ability to prevent liquid slugging and subsequent oil pump-out at the beginning and end of the defrost cycle should be assessed during system development. This will require special accumulators and compressors with sight tubes and/or sight glasses for monitoring refrigerant and oil levels.

Charge Compensators

Charge compensators are devices that store excess refrigerant during the heating operation of a heat pump with a TXV refrigerant control. Unlike an orifice, a TXV will not allow excessive refrigerant to flood back to the compressor. This means that the excess system refrigerant will either have to back up in the indoor coil during heating, causing high head pressure, or be stored in a charge compensator until needed. A charge compensator is normally a hollow vessel with only one opening that is attached to the vapor line. The shell is usually attached to the outdoor coil or has a line from the outdoor coil running through it for extra cooling during heating and to drive the refrigerant out during the cooling cycle. The size is dependent on how much refrigerant has to be removed from the system throughout the system operating map.

Screens

Screens finer than 30x30 mesh (0.6mm openings) should not be used anywhere in the system with these compressors. Field experience has shown that finer mesh screens used to protect thermal expansion valves, capillary tubes, or accumulators can become temporarily or permanently plugged with normal system debris and block the flow of either oil or refrigerant to the compressor. Such blockage can result in compressor failure.

Crankcase Heat - Single Phase

A crankcase heater is recommended on single phase compressors when the system charge is over the charge limit shown in **Table 4**. A crankcase heater is required for systems containing more than 120% of the compressor refrigerant charge limit listed in **Table 5**. This includes long line length systems where the extra charge will increase the standard factory charge above the 120% limit.

Experience has shown that compressors may fill with liquid refrigerant under certain circumstances and system configurations, notably after long off cycles when the compressor has cooled. This may cause excessive start-up clearing noise; or the compressor may start and trip the internal overload protector several times before running. The addition of a crankcase heater will reduce customer noise and dimming light complaints since the compressor will no longer have to clear out liquid during starting. **Table 4** lists the crankcase heaters recommended for the various models and voltages. **WARNING! Crankcase heaters must be properly grounded.** To properly install the crankcase heater, the heater should be installed as low on the compressor shell as possible, either above or below the lower bearing pin welds that protrude from the compressor shell. Ideally the heater would come together for clamping with the vertical shell seam weld coming up through the area where the crankcase heater is clamped together. See **Figure 6** for details. Tighten the clamp screw carefully ensuring that the heater is uniformly tensioned along its entire length and that the circumference of the heater element is in complete contact with the compressor shell. It's important that the clamp screw is torqued to the range of 20-25 in-lb (2.3-8 N m) to ensure adequate contact and to prevent heater burnout. Never apply power to heater in free air or before heater is installed on compressor to prevent overheating and burnout.

Crankcase Heat - Three Phase

A crankcase heater is required for three-phase compressors when the system charge exceeds the

compressor charge limit listed in **Table 5** and an accumulator cannot be piped to provide free liquid drainage during the off cycle (See **Figure 2** and **Table 4**).

Pump Down Cycle

A pump down cycle for control of refrigerant migration is not recommended for scroll compressors of this size. **If a pump down cycle is used, a separate discharge line check valve must be added.** The scroll compressor's discharge check valve is designed to stop extended reverse rotation and prevent high-pressure gas from leaking rapidly into the low side after shut off. The check valve will in some cases leak more than reciprocating compressor discharge reeds, normally used with pump down, causing the scroll compressor to recycle more frequently. Repeated short-cycling of this nature can result in a low oil situation and consequent damage to the compressor. The low-pressure control differential has to be reviewed since a relatively large volume of gas will re-expand from the high side of the compressor into the low side on shut down. **Pressure control setting: Never set the low pressure control to shut off outside of the operating envelope. The exception to this rule is the heat pump as explained on Page 3. To prevent the compressor from running into problems during such faults as loss of charge or partial blockage, the control should not be set lower than 5 to 10°F (3-6K) equivalent suction pressure below the lowest design operating point.**

Minimum Run Time

There is no set answer to how often scroll compressors can be started and stopped in an hour, since it is highly dependent on system configuration. Other than the considerations in the section on Brief Power Interruptions, there is no minimum off time because Copeland Scroll compressors start unloaded, even if the system has unbalanced pressures. The most critical consideration is the minimum run time required to return oil to the compressor after startup. To establish the minimum run time, obtain a sample compressor equipped with a sight tube (available from Emerson) and install it in a system with the longest connecting lines that are approved for the system. The minimum on time becomes the time required for oil lost during compressor startup to return to the compressor sump and restore a minimal oil level that will assure oil pick up through the crankshaft. Cycling the compressor for a shorter period than this, for instance to maintain very tight temperature control, will result in progressive loss of oil and damage to the compressor. See **AE17-1262** for more information on preventing compressor short cycling.

Reversing Valves

Since Copeland Scroll compressors have very high volumetric efficiency, their displacements are lower than those of comparable capacity reciprocating compressors. **CAUTION Reversing valve sizing must be within the guidelines of the valve manufacturer. Required pressure drop to ensure valve shifting must be measured throughout the operating range of the unit and compared to the valve manufacturer's data. Low ambient heating conditions with low flow rates and low pressure drop across the valve can result in a valve not shifting. This can result in a condition where the compressor appears to be not pumping (i.e. balanced pressures). It can also result in elevated compressor sound levels.** During a defrost cycle, when the reversing valve abruptly changes the refrigerant flow direction, the suction and discharge pressures will go outside of the normal operating envelope. The sound that the compressor makes during this transition period is normal, and the duration of the sound will depend on the coil volume, outdoor ambient, and system charge. The preferred method of mitigating defrost sound is to shut down the compressor for 20 to 30 seconds when the reversing valve changes position going into and coming out of the defrost cycle. This technique allows the system pressures to reach equilibrium without the compressor running. The additional start-stop cycles do not exceed the compressor design limits, but suction and discharge tubing design should be evaluated.

The reversing valve solenoid should be wired so that the valve does not reverse when the system is shut off by the operating thermostat in the heating or cooling mode. If the valve is allowed to reverse at system shutoff, suction and discharge pressures are reversed to the compressor. This results in pressures equalizing through the compressor which can cause the compressor to slowly rotate backwards until the pressures equalize. This condition does not affect compressor durability but can cause unexpected sound after the compressor is turned off.

Low Ambient Cut-Out

A low ambient cut-out is not required to limit air-to-air heat pump operation. Air-to-water heat pumps must be reviewed since this configuration could possibly run outside of the approved operating envelope (**Figure 7**) causing overheating or excessive wear.

Oil Type

Polyol ester (POE) oil is used in these compressors. See the compressor nameplate for the original oil charge. A complete recharge should be approximately

four fluid ounces (118 ml) less than the nameplate value. If additional oil is needed in the field, Copeland™ Ultra 32-3MAF, Lubrizol Emkarate RL32-3MAF, Parker Emkarate RL32-3MAF/(Virginia) LE32-3MAF, or Nu Calgon 4314-66 (Emkarate RL32-3MAF) should be used. Copeland™ Ultra22 CC, Hatcol EAL22CC, and Mobil EAL Arctic 22 CC are acceptable alternatives.

CAUTION! POE must be handled carefully and the proper protective equipment (gloves, eye protection, etc.) must be used when handling POE lubricant. POE must not come into contact with any surface or material that might be harmed by POE, including without limitation, certain polymers (e.g. PVC/CPVC and polycarbonate).

Contaminant Control

Copeland Scroll compressors leave the factory with a miniscule amount of contaminants. Manufacturing processes have been designed to minimize the introduction of solid or liquid contaminants. Dehydration and purge processes ensure minimal moisture levels in the compressor and continuous auditing of lubricant moisture levels ensure that moisture isn't inadvertently introduced into the compressor.

It is generally accepted that system moisture levels should be maintained below 50 ppm. **A filter-drier is required on all R-410A and POE lubricant systems to prevent solid particulate contamination, oil dielectric strength degradation, ice formation, oil hydrolysis, and metal corrosion.** It is the system designer's responsibility to make sure the filter-drier is adequately sized to accommodate the contaminants from system manufacturing processes that leave solid or liquid contaminants in the evaporator coil, condenser coil, and interconnecting tubing plus any contaminants introduced during the field installation process. Molecular sieve and activated alumina are two filter-drier materials designed to remove moisture and mitigate acid formation. A 100% molecular sieve filter can be used for maximum moisture capacity. A more conservative mix, such as 75% molecular sieve and 25% activated alumina, should be used for service applications.

Long Line Sets/High Refrigerant Charge

Some system configurations may contain higher-than-normal refrigerant charges either because of large internal coil volumes or long line sets. If such a system also contains an accumulator then the permanent loss of oil from the compressor may become critical. If the system contains more than 20 pounds (9 kg) of refrigerant, it is our recommendation to add one fluid ounce of oil for every 5 pounds (15 ml/kg) of refrigerant

over this amount. If the system contains an accumulator the manufacturer of the accumulator should be consulted for a pre-charge recommendation.

Other system components such as shell and tube evaporators can trap significant quantities of oil and should be considered in overall oil requirements. Reheat coils and circuits that are inactive during part of the normal cycle can trap significant quantities of oil if system piping allows the oil to fall out of the refrigerant flow into an inactive circuit. The oil level must be carefully monitored during system development, and corrective action should be taken if compressor oil level falls below the top of the lower bearing bracket for more than two minutes. The lower bearing bracket weld points on the compressor shell can be used as a low-oil-level marker.

Discharge Mufflers

Flow through Copeland Scroll compressors is semi-continuous with relatively low pulsation. External mufflers, where they are normally applied to piston compressors today, may not be required for Copeland Scroll compressors. Because of variability between systems, however, individual system tests should be performed to verify acceptability of sound performance. When no testing is performed, mufflers are recommended in heat pumps. A hollow shell muffler such as the Emerson Flow Controls APD-1 or APD-054 will work quite well. The mufflers should be located a minimum of six inches (15 cm) to a maximum of 18 inches (46 cm) from the compressor for most effective operation. The farther the muffler is placed from the compressor within these ranges the more effective it may be. If adequate attenuation is not achieved, use a muffler with a larger cross-sectional area to inlet-area ratio. The ratio should be a minimum of 20:1 with a 30:1 ratio recommended. The muffler should be from four to six inches (10 -15 cm) long.

Air Conditioning System Suction Line Noise and Vibration

Copeland Scroll compressors inherently have low sound and vibration characteristics. However, the sound and vibration characteristics differ in some respects from those of reciprocating compressors. In rare instances, these could result in unexpected sound complaints.

One difference is that the vibration characteristics of the scroll compressor, although low, include two very close frequencies, one of which is normally isolated from the shell by the suspension of an internally suspended compressor. These frequencies, which are present in all compressors, may result in a low level “beat” frequency that may be detected as noise coming along the suction line into a house under some conditions. Elimination

of the “beat” can be achieved by attenuating either of the contributing frequencies. The most important frequencies to avoid are 50 and 60 Hz power supply line and twice-line frequencies for single-phase compressors and line frequency for three phase compressors. This is easily done by using one of the common combinations of design configuration described in **Table 3**. The scroll compressor makes both a rocking and torsional motion, and enough flexibility must be provided in the line to prevent vibration transmission into any lines attached to the unit. In a split system the most important goal is to ensure minimal vibration is all directions at the service valve to avoid transmitting vibrations to the structure to which the lines are fastened.

A second difference of the Copeland Scroll compressor is that under some conditions the normal rotational starting motion of the compressor can transmit an “impact” noise along the suction line. This may be particularly pronounced in three-phase models due to their inherently higher starting torque. This phenomenon, like the one described previously, also results from the lack of internal suspension, and can be easily avoided by using standard suction line isolation techniques as described in **Table 3**.

The sound phenomena described above are not usually associated with heat pump systems because of the isolation and attenuation provided by the reversing valve and tubing bends.

Mounting Parts

All ZP16-44K3 and ZP34-61K5 compressors have extruded grommet mounting holes, so the grommet must have a relief cut into the main body to accommodate the down-turned lip of the hole. **Table 4** lists the mounting parts kits to be used with these compressors. Many OEM customers buy the mounting parts directly from the supplier, but Emerson’s grommet design and durometer recommendation should be followed for best vibration reduction through the mounting feet. Please see **AE4-1111** for grommet mounting suggestions and supplier addresses.

Single Phase Starting Characteristics

Start assist devices are usually not required, even if a system utilizes non-bleed expansion valves. Due to the inherent design of the Copeland Scroll compressor, the internal compression components always start unloaded even if system pressures are not balanced. In addition, since internal compressor pressures are always balanced at startup, low voltage starting characteristics are excellent for Copeland Scroll compressors. The starting **Locked Rotor Amperage (LRA)**, also referred to as **inrush current**, is normally six or more times higher

than the rated running amperage of the compressor and lasts from 100 to 300 milliseconds until the rotor starts turning. This high starting current may result in significant “sag” in voltage where a poor power supply is encountered. Low starting voltage reduces the starting torque of the compressor and subsequently increases the time the compressor is in a locked rotor condition. This could cause light dimming or a buzzing noise where wire is pulled through conduit. Start components will substantially reduce start time and consequently the magnitude and duration of both light dimming and conduit buzzing. Specified starting components can be found in the Online Product Information section of www.emersonclimate.com.

PTC Start Components

For less severe voltage drops or as a start boost, solid state Positive Temperature Coefficient (PTC) devices rated from 10 to 25 ohms may be used to facilitate starting for any of these compressors.

Electrical Connections



Molded electrical plug (Emerson p/n 529-0060-04 or OEM equivalent) must be used with all -1XX and -8XX bills of material.

The orientation of the electrical connections on the Copeland Scroll compressors is shown in **Figure 4**. Two electrical connection options are available for these compressors. These include the “Molded Plug” one piece push-on connection, available in certain models; and “Quick Connect” flag termination available only on the ZP*K3 scrolls. **CAUTION Never operate the compressor without the terminal box cover installed.**

Deep Vacuum Operation

Copeland Scroll compressors incorporate internal low vacuum protection and will stop pumping (unload) when the pressure ratio exceeds approximately 10:1. There is an audible increase in sound when the scrolls start unloading.

CAUTION Copeland Scroll compressors (as with any refrigerant compressor) should never be used to evacuate a refrigeration or air conditioning system. The scroll compressor can be used to pump down refrigerant in a unit as long as the pressures remain within the operating envelope shown in **Figure 7**. Prolonged operation at low suction pressures will result in overheating of the scrolls and permanent damage to the scroll tips, drive bearing and internal seal. See **AE24-1105** for proper system evacuation procedures.

Shell Temperature



Compressor top cap temperatures can be very hot. Care must be taken to ensure that wiring or other materials which could be damaged by these temperatures do not come into contact with these potentially hot areas.

Certain types of system failures, such as condenser or evaporator fan blockage or loss of charge, may cause the top shell and discharge line to briefly or repeatedly reach temperatures above 350°F (177°C) as the compressor cycles on its internal overload protection device. Care must be taken to ensure that wiring or other materials which could be damaged by these temperatures do not come into contact with these potentially hot areas.

Suction and Discharge Fittings

Copeland Scroll compressors have copper plated steel suction and discharge fittings. These fittings are far more rugged and less prone to leaks than copper fittings used on other compressors. Due to the different thermal properties of steel and copper, brazing procedures may have to be changed from those commonly used. See **Figure 8** for assembly line and field brazing recommendations.

System Tubing Stress

System tubing should be designed to keep tubing stresses below 9.5 ksi (62 MPa), the endurance limit of copper tubing. Start, stop and running (resonance) cases should be evaluated.

Three Phase Scroll Compressor Electrical Phasing

Copeland Scroll compressors, like several other types of compressors, will only compress in one rotational direction. Direction of rotation is not an issue with single phase compressors since they will always start and run in the proper direction (except as described in the section “Brief Power Interruptions”). Three phase compressors will rotate in either direction depending upon phasing of the power. Since there is a 50% chance of connecting power in such a way as to cause rotation in the reverse direction, **it is important to include notices and instructions in appropriate locations on the equipment to ensure that proper rotation direction is achieved when the system is installed and operated.** Verification of proper rotation direction is made by observing that suction pressure drops and discharge pressure rises when the compressor is energized. Reverse rotation will result in

no pressure differential as compared to normal values. A compressor running in reverse will sometimes make an abnormal sound.

There is no negative impact on durability caused by operating three phase Copeland Scroll compressors in the reversed direction for a short period of time (under one hour). After several minutes of reverse operation, the compressor's internal overload protector will trip shutting off the compressor. If allowed to repeatedly restart and run in reverse without correcting the situation, the compressor bearings will be permanently damaged because of oil loss to the system. All three-phase scroll compressors are wired identically internally. As a result, once the correct phasing is determined for a specific system or installation, connecting properly phased power leads to the identified compressor electrical (Fusite™) terminals will maintain the proper rotational direction (see **Figure 4**). It should be noted that all three phase scrolls will continue to run in reverse until the internal overload protector opens or the phasing is corrected.

Brief Power Interruptions

Brief power interruptions (less than ½ second) may result in powered reverse rotation of single-phase Copeland Scroll compressors. This occurs because high-pressure discharge gas expands backward through the scrolls during interruption, causing the scroll to orbit in the reverse direction. When power is reapplied while reverse rotation is occurring, the compressor may continue to run in the reverse direction for some time before the compressor's internal overload trips. This will not cause any damage to the compressor, and when the internal overload resets, the compressor will start and run normally.

To avoid disruption of operation, an electronic control that can sense brief power interruptions may be used to lock out the compressor for a short time. This control could be incorporated in other system controls (such as defrost control board or the system thermostat), or can be a stand-alone control. Functional specifications for this control as well as a suggested wiring diagram are shown in **Figure 3**. No time delay is necessary for three phase models since the motor starting torque is high enough to overcome reverse rotation.

A start kit (specified start capacitor and relay) is another effective means of mitigating a powered reverse condition that is caused by a brief power interruption.

Manifolding Tandem Compressors

All of the ZPK5 compressors are available for manifolding with another ZPK5 compressor of equal

capacity. These compressors are designated with a -4XX bill of material number at the end of the model number (e.g. ZP25K5E-PFV-498). See **Figure 10** for a picture of an assembled tandem showing the hardware and parts required for assembly. Drawings of tandem tubing assemblies are available from Emerson Climate Technologies by contacting your Applications Engineer.

Tandem Applications

Tandem compressors following the same application guidelines as single compressors outlined in this bulletin. The refrigerant charge limit for tandem compressors is shown in **Table 5**. A three-phase unit with a charge over this limit must have crankcase heaters applied to both compressors.

The compressors in a tandem set can be started/stopped in any desired sequence. To help reduce the probability of light dimming, starting the compressors individually is recommended.

Maximum Tilt Angle

OEMs and end-users often ask about the maximum allowable tilt angle of the compressor. Some applications, such as transportation air-conditioning or mobile radar applications, may require the compressor to operate at some angle from vertical. Or, service personnel may be required to maneuver a unit through a stairwell or other cramped area that might require tilting the unit. The maximum allowable tilt angles from horizontal are summarized below:

Max Tilt Angle With Compressor Running = 15°

Max Tilt Angle With Compressor Not Running = 60°

APPLICATION TESTS

Application Test Summary

There are a minimal number of tests the system designer will want to run to ensure the system operates as designed. These tests should be performed during system development and are dependent on the system type and amount of refrigerant charge. These application tests are to help identify gross errors in system design that may produce conditions that could lead to compressor failure. The Continuous Floodback Test and Field Application Test, both outlined below, are two tests to run to help verify the design. When to run these tests can be summarized as follows:

Continuous Floodback:

Required on all heatpumps.

Field Application Test:

Required for any unit where both the design system charge is higher than the compressor refrigerant

charge limit listed in Table 5; and a capillary tube, fixed orifice, or bleed-type TXV is used on either the indoor or the outdoor coil of the unit.

Continuous Floodback Test

It is expected that the design would not flood during standard air conditioning operation. Running a partially blocked indoor air filter or loss of evaporator air flow test and comparing the sump temperature results to **Figure 1** is recommended. The use of a TXV in heating does not guarantee operation without flood back in the lower end of the unit/TXV operating range.

To test for excessive continuous liquid refrigerant flood back, it is necessary to operate the system in a test room at conditions where steady state flood back may occur (low ambient heating operation). Thermocouples should be attached with glue or solder to the center of the bottom shell and to the suction and discharge lines approximately 6 inches (15 cm) from the shell. These thermocouples should be insulated from the ambient air with Permagum® or other thermal insulation to be able to record true shell and line temperatures. If the system is designed to be field charged, it should be overcharged by 15% in this test to simulate overcharging often found in field installations.

The system should be operated at an indoor temperature of 70°F (21°C) and outdoor temperature extremes of 10°F (-12°C) or lower in heating to produce flood back conditions. The compressor suction and discharge pressures and temperatures as well as the sump temperature should be recorded. The system should be allowed to frost up for several hours (disabling the defrost control and spraying water on the outdoor coil may be necessary) to cause the saturated suction temperature to fall below 0°F (-18°C). The compressor sump temperature must remain above the sump temperature shown in **Figure 1** or design changes must be made to reduce the amount of flood back. If an accumulator is used, this test can be used to test the effectiveness of the accumulator. Increasing indoor coil volume, increasing outdoor air flow, reducing refrigerant charge, decreasing capillary or orifice diameter, and adding a charge compensator can also be used to reduce excessive continuous liquid refrigerant flood back.

Field Application Test

To test for repeated, excessive liquid flood back during normal system off-cycles, perform the **Field Application Test** that is outlined in **Table 2**. Obtain a sample compressor with a sight-tube to measure the liquid level in the compressor when it is off.

Note: The sight-tube is not a good liquid level indicator when the compressor is running because the top of the

sight-tube is at a lower pressure than the bottom causing a higher apparent oil level.

Set the system up in a configuration with the indoor unit elevated several feet above the outdoor unit with a minimum of 25 feet (8 meters) of connecting tubing with no traps between the indoor and outdoor units. If the system is designed to be field charged, the system should be overcharged by 15% in this test to simulate field overcharging. Operate the system in the cooling mode at the outdoor ambient, on/off cycle times, and number of cycles specified in **Table 2**. Record the height of the liquid in the compressor at the start of each on cycle, any compressor overload trips, or any compressor abnormal starting sounds during each test. Review the results with Application Engineering to determine if an accumulator or other means of off cycle migration control are required. **This test does not eliminate the requirement for a crankcase heater if the system charge level exceeds the values in Table 5.** The criteria for pass/fail is whether the liquid level reaches the level of the compressor suction tube connection. Liquid levels higher than this can allow refrigerant/oil to be ingested by the scrolls and pumped out of the compressor after start-up.

The tests outlined above are for common applications of compressors in this family. Many other applications of the compressor exist, and tests to insure those designs can't possibly be covered in this bulletin. Please consult with Application Engineering on applications outside of those outlined above for the appropriate application tests.

ASSEMBLY LINE PROCEDURES

Installing the Compressor



Use care and the appropriate material handling equipment when lifting and moving compressors. Personal safety equipment must be used.

Copeland Scroll compressors leave the factory dehydrated and with a positive dry air charge. Plugs should not be removed from the compressor until the compressor has had sufficient time to warm up if stored outside and is ready for assembly in the unit. The suggested warm up time is one hour per 4°F (2K) difference between outdoor and indoor temperature. It is suggested that the larger suction plug be removed first to relieve the internal pressure. Removing the smaller discharge plug could result in a spray of oil out of this fitting since some oil accumulates in the head of the compressor after Emerson's run test. The inside of both fittings should be wiped with a lint free cloth

to remove residual oil prior to brazing. A compressor containing POE oil should never be left open longer than 5 minutes.

Assembly Line Brazing Procedure

WARNING

Personal safety equipment must be used during brazing operation. Heat shields should be used to prevent overheating or burning nearby temperature sensitive parts. Fire extinguishing equipment should be accessible in the event of a fire.

Figure 8 discusses the proper procedures for brazing the suction and discharge lines to a scroll compressor. **NOTICE It is important to flow nitrogen through the system while brazing all joints during the system assembly process.** Nitrogen displaces the air and prevents the formation of copper oxides in the system. If allowed to form, the copper oxide flakes can later be swept through the system and block screens such as those protecting capillary tubes, thermal expansion valves, and accumulator oil return holes. Any blockage of oil or refrigerant may damage the compressor resulting in failure.

Tandem Assembly

WARNING

When lifting tandem compressor assemblies, both compressors must be lifted by their respective lifting rings. Use care and exercise extreme caution when lifting and moving compressors. Personal safety equipment must be used.

The first step in the tandem assembly process is to securely mount both compressors to the rails using the appropriate mounting hardware listed in Table 4. After both compressors are mounted to the rails, the suction, discharge, and gas equalization manifolds can be brazed to the appropriate stub tubes of each compressor using standard brazing practices with a nitrogen purge. Special consideration needs to be given to the oil equalization line that connects the oil sumps of the two compressors. The oil in the single, tandem ready compressor is located at the center of the oil equalization fitting. After both compressors are mounted to the compressor rails and prior to removing the rubber plug in the oil equalization stubs, the assembly should be tilted back a minimum of 12° from horizontal (see Figure 11) to move the oil level away from the oil equalization fitting for brazing. The oil equalization stubs of both compressors should be wiped clean with a lint free towel to remove any oil residue before brazing.

Pressure Testing

WARNING

Never pressurize the compressor to more than 475 psig (32.8 bar) for leak checking purposes. Never pressurize the compressor from a nitrogen cylinder or other pressure source without an appropriately sized pressure regulating and relief valve.

The pressure used on the line to meet the UL burst pressure requirement must not be higher than 475 psig (33 Bar). Higher pressure may result in permanent deformation of the compressor shell and possible misalignment or bottom cover distortion.

Assembly Line System Charging Procedure

Systems should be charged with liquid on the high side to the extent possible. The majority of the charge should be pumped in the high side of the system to prevent low voltage starting difficulties, hipot failures, and bearing washout during the first-time start on the assembly line. If additional charge is needed, it should be added as **liquid** to the low side of the system with the compressor operating. Pre-charging on the high side and adding liquid on the low side of the system are both meant to protect the compressor from operating with abnormally low suction pressures during charging. **NOTICE Do not operate the compressor without enough system charge to maintain at least 55 psig (3.8 bar) suction pressure. Do not operate the compressor with the low pressure cut-out disabled. Do not operate with a restricted suction or liquid line.** Depending on the discharge pressure, allowing pressure to drop below 55 psig (3.8 bar) for more than a few seconds may overheat the scrolls and cause early drive bearing damage. **NOTICE Do not use the compressor to test the opening set point of a high pressure cutout.** Bearings are susceptible to damage before they have had several hours of normal running for proper break in.

“Hipot” (AC High Potential) Testing

CAUTION

Use caution with high voltage and never hipot when compressor is in a vacuum.

Copeland Scroll compressors are configured with the motor down and the pumping components at the top of the shell. As a result, the motor can be immersed in refrigerant to a greater extent than hermetic reciprocating compressors when liquid refrigerant is present in the shell. In this respect, the scroll is more like semi-hermetic compressors that have horizontal

motors partially submerged in oil and refrigerant. When Copeland Scroll compressors are hipot tested with liquid refrigerant in the shell, they can show higher levels of leakage current than compressors with the motor on top. This phenomenon can occur with any compressor when the motor is immersed in refrigerant. The level of current leakage does not present any safety issue. To lower the current leakage reading, the system should be operated for a brief period of time to redistribute the refrigerant to a more normal configuration and the system hipot tested again. See **AE4-1294** for megohm testing recommendations. **Under no circumstances should the hipot test be performed while the compressor is under a vacuum.**

Final Run Test

Customers that use a nitrogen final run test must be careful to not overheat the compressor. Nitrogen is not a good medium for removing heat from the compressor, and the scroll tips can be easily damaged with high compression ratios and/or long test times. Copeland Scroll compressors are designed for use with refrigerant, and testing with nitrogen may result in a situation where the compressor does not develop a pressure differential (no pump condition). When testing with nitrogen, the compressor must be allowed to cool for several minutes between tests.

Single phase scrolls with an electrical nomenclature of "PFV" (208-230 volt, 1Ø, 60 Hertz) at the end of the model number are guaranteed to start at 187 volts or higher and must have a voltage no lower than 197 volts once the compressor is running under load. All other compressor voltages, both single and three phase, 50 & 60 Hertz are guaranteed to start and run at 10% below the lowest voltage shown on the nameplate.

Variable transformers used on assembly lines are often incapable of maintaining the starting voltage when larger compressors are tested. To test for voltage sag during starting, the first compressor in a production run should be used to preset the voltage. Remove the start wire from the compressor and apply 200 volts to the compressor. With the start winding removed, the compressor will remain on locked rotor long enough to read the supply voltage. If the voltage sags below the minimum guaranteed starting voltage, the variable transformer must be reset to a higher voltage. When discussing this starting amperage it should be noted that "inrush current" and locked rotor amps (LRA) are one and the same. The nameplate LRA is determined by physically locking a compressor and applying the highest nameplate voltage to the motor. The amperage that the motor

draws after four seconds is the value that is used on the nameplate. Since there is a direct ratio between voltage and locked rotor amperage, the lower the line voltage used to start the compressor, the lower the locked rotor amperage will be.

Unbrazing System Components



Before attempting to braze, it is important to recover all refrigerant from both the high and low side of the system.

If the refrigerant charge is removed from a scroll-equipped unit by recovering one side only, it is very possible that either the high or low side of the system remains pressurized. If a brazing torch is then used to disconnect tubing, the pressurized refrigerant and oil mixture could ignite when it escapes and contacts the brazing flame. Instructions should be provided in appropriate product literature and assembly (line repair) areas. If compressor removal is required, the compressor should be cut out of the system rather than unbrazed. See **Figure 8** for proper compressor removal procedure.

SERVICE PROCEDURES

Copeland Scroll Compressor Functional Check

A functional compressor test during which the suction service valve is closed to check how low the compressor will pull the suction pressure is not a good indication of how well a compressor is performing. **Such a test will damage a scroll compressor in a few seconds.** The following diagnostic procedure should be used to evaluate whether a Copeland Scroll compressor is functioning properly:

1. Proper voltage to the unit should be verified.
2. Determine if the internal motor overload has opened or if an internal motor short or ground fault has developed. If the internal overload has opened, the compressor must be allowed to cool sufficiently to allow it to reset.
3. Check that the compressor is correctly wired.
4. Proper indoor and outdoor blower/fan operation should be verified.
5. With service gauges connected to suction and discharge pressure fittings, turn on the compressor. If suction pressure falls below normal levels the system is either low on charge or there is a flow blockage in the system.

6. **Single phase compressors** – If the compressor starts and the suction pressure does not drop and discharge pressure does not rise to normal levels, either the reversing valve (if so equipped) or the compressor is faulty. Use normal diagnostic procedures to check operation of the reversing valve. **Three phase compressors** – If suction pressure does not drop and discharge pressure does not rise to normal levels, reverse any two of the compressor power leads and reapply power to make sure the compressor was not wired to run in reverse. If pressures still do not move to normal values, either the reversing valve (if so equipped) or the compressor is faulty. Reconnect the compressor leads as originally configured and use normal diagnostic procedures to check operation of the reversing valve.
7. To test if the compressor is pumping properly, the compressor current draw must be compared to published compressor performance curves using the operating pressures and voltage of the system. If the measured average current deviates more than +/-20% from published values, a faulty compressor may be indicated. A current imbalance exceeding 20% of the average on the three phases of a three-phase compressor should be investigated further. A more comprehensive trouble-shooting sequence for compressors and systems can be found in Section H of the **Emerson Climate Technologies Electrical Handbook, Form No. 6400**.
8. Note that ZP20K5-ZP31K5 three-phase models use uniquely designed motors that do not have equal resistances on all three windings. Resistance may differ from leg-to-leg as much as 30%. Refer to related data in Online Product Information (OPI) for published resistance specifications for a specific model. Carefully compare measured motor resistance values to published values before replacing the compressor as being defective. Resistance values and other technical data can be found at emersonclimate.com or from the Copeland Mobile App. The larger ZP34K5-ZP61K5 and older ZP*K3 compressors have conventional three-phase motors with equal resistances in each winding.
9. Before replacing or returning a compressor, be certain that the compressor is actually defective. As a minimum, recheck compressors returned from the field in the shop or depot by testing for a grounded, open or shorted winding and the ability to start. The orange tag in the service compressor box should be filled out and attached to the failed

compressor to be returned. The information on this tag is captured in our warranty data base.

Compressor Replacement After a Motor Burn

In the case of a motor burn, the majority of contaminated oil will be removed with the compressor. The rest of the oil is cleaned with the use of suction and liquid line filter driers. A 100% activated alumina suction filter drier is recommended but must be removed after 72 hours. See **AE24-1105** for clean up procedures and **AE11-1297** for liquid line filter-drier recommendations. **NOTICE It is highly recommended that the suction accumulator be replaced if the system contains one.** This is because the accumulator oil return orifice or screen may be plugged with debris or may become plugged shortly after a compressor failure. This will result in starvation of oil to the replacement compressor and a second failure. The system contactor should be inspected for pitted/burnt contacts and replaced if necessary. It is highly recommended that the run capacitor be replaced when a single phase compressor is replaced.

Start-Up of a New or Replacement Compressor

It is good service practice, when charging a system with a scroll compressor, to charge liquid refrigerant into the high side only. It is not good practice to dump liquid refrigerant from a refrigerant cylinder into the crankcase of a stationary compressor. If additional charge is required, charge liquid into the low side of the system with the compressor operating. **CAUTION Do not start the compressor while the system is in a deep vacuum.** Internal arcing may occur when any type of compressor is started in a vacuum. **NOTICE Do not operate the compressor without enough system charge to maintain at least 55 psig (3.8 bar) suction pressure. Do not operate with a restricted suction or liquid line. Do not operate with the low pressure cut-out disabled.** Allowing suction pressure to drop below 55 psig (3.8 bar) for more than a few seconds may overheat the scrolls and cause early drive bearing damage. Never install a system in the field and leave it unattended with no charge, a holding charge, or with the service valves closed without securely locking out the system. This will prevent unauthorized personnel from accidentally ruining the compressor by operating with no refrigerant flow.

Tandem Service

Should a compressor fail in the tandem set the complete tandem should be removed from the unit and replaced with a new tandem set. Replacing individual compressors is discouraged because of the care that must be used when installing the oil equalization tube and the availability of manifolds to the aftermarket.

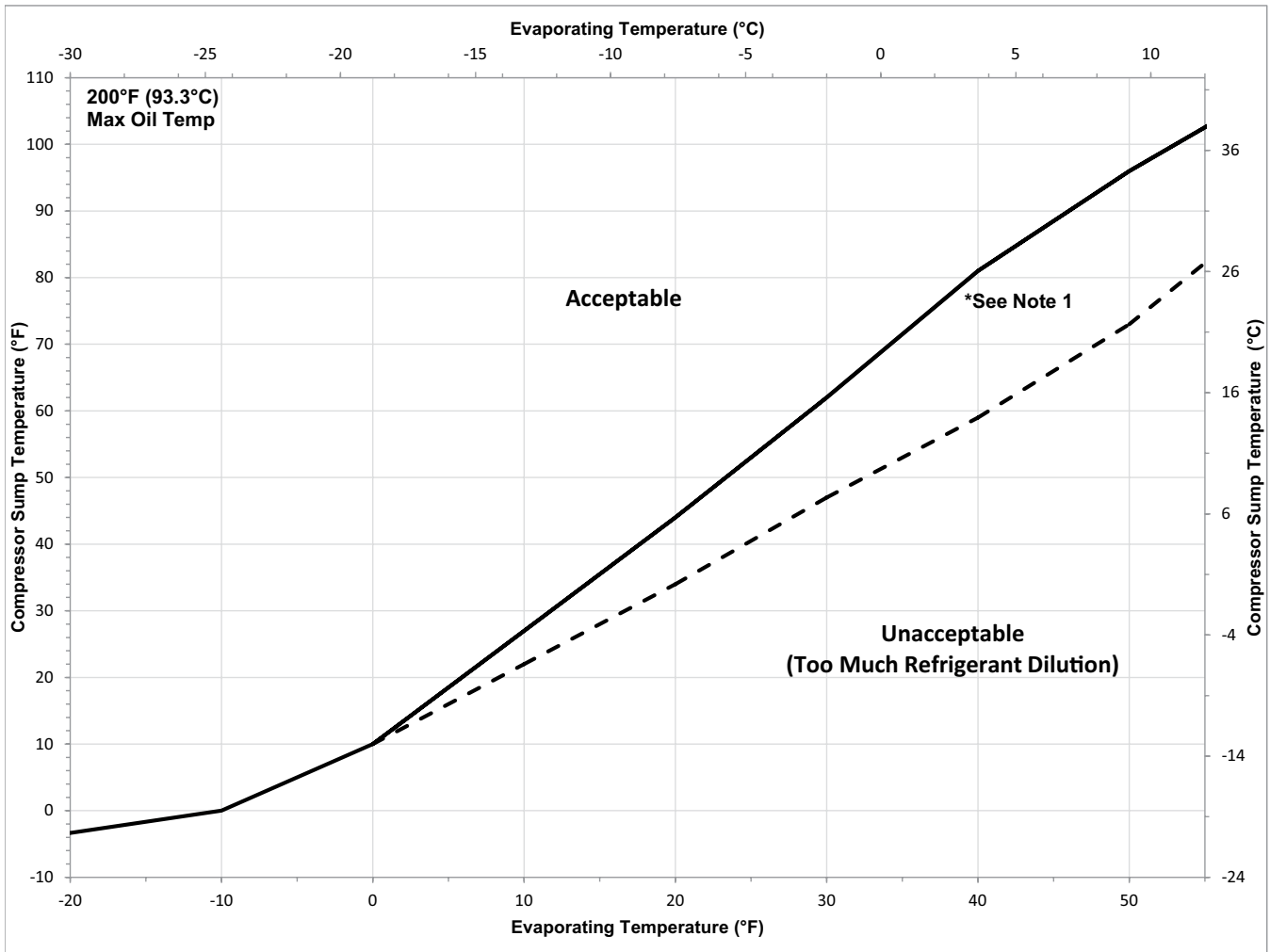

Note 1: Operation in this refrigerant dilution area is safe in air-to-air heat pump heating mode. For other applications, such as AC only, review expansion device to raise superheat. A cold sump may result in high refrigerant migration after shut down.

Figure 1
Oil Dilution Chart

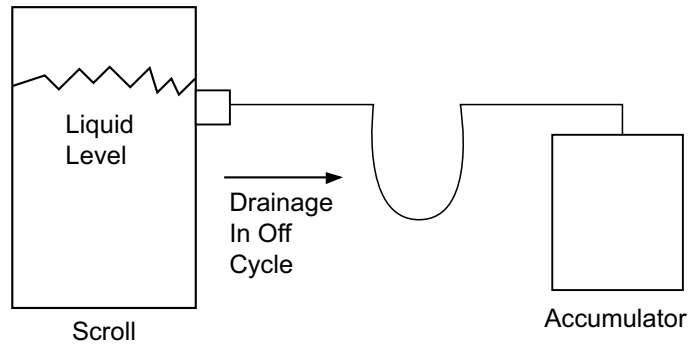

To prevent flooded start damage due to off cycle migration, the accumulator may be configured on some systems to allow free drainage from the compressor to the accumulator during the off cycle. When the above configuration is not possible and the unit charge is over the charge limit shown in Table 5, a crankcase heater is required.

Figure 2
Accumulator Piping

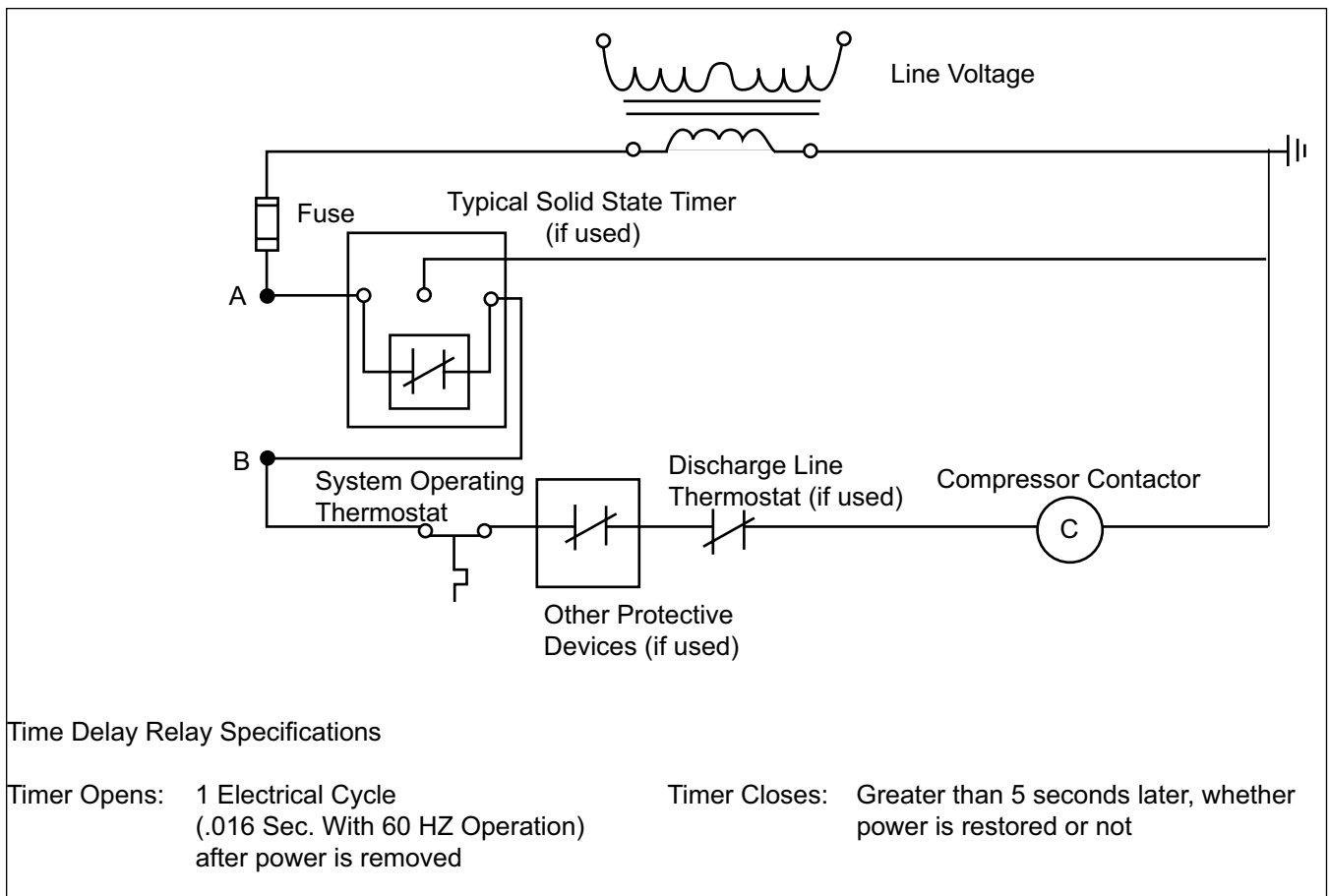

Figure 3
Time Delay Wiring

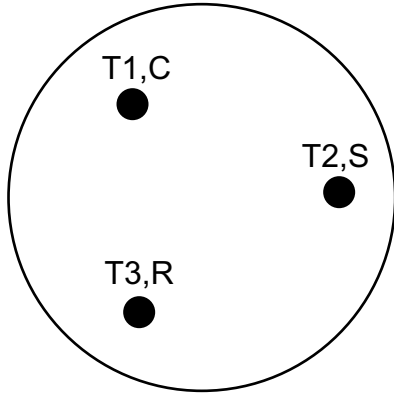

Figure 4
Compressor Electrical Connection

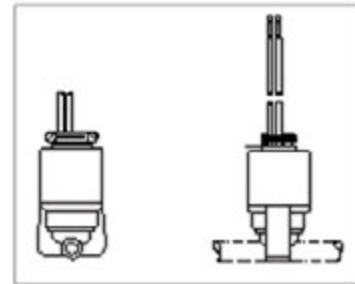
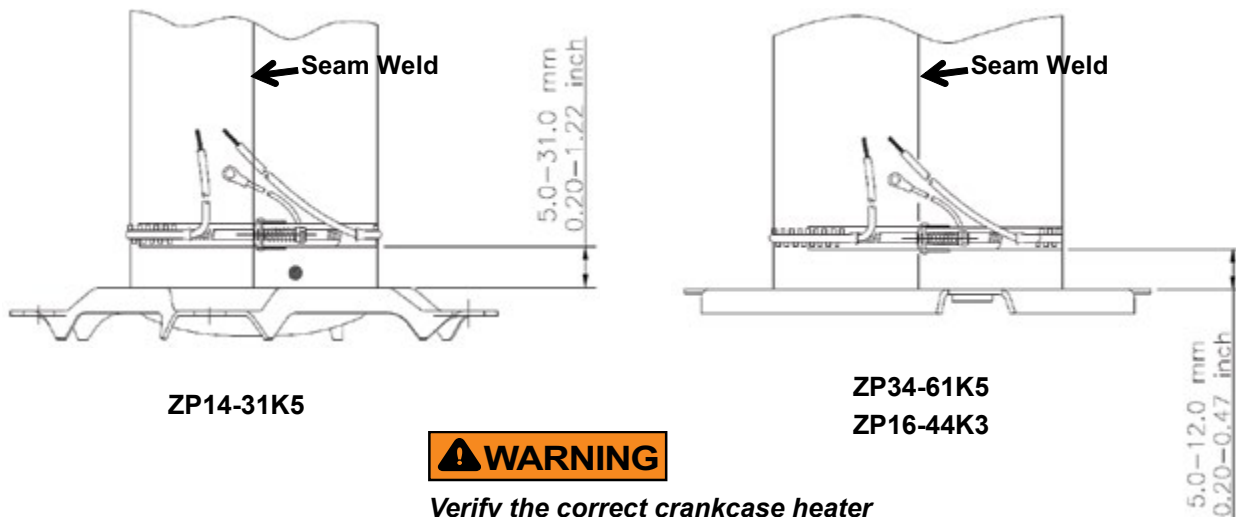

Figure 5
Discharge Thermostat

Connect the heater so that the connection point straddles the compressor seam weld



⚠ WARNING

Verify the correct crankcase heater voltage for the application and ensure heater is properly grounded.

Figure 6
Crankcase Heater

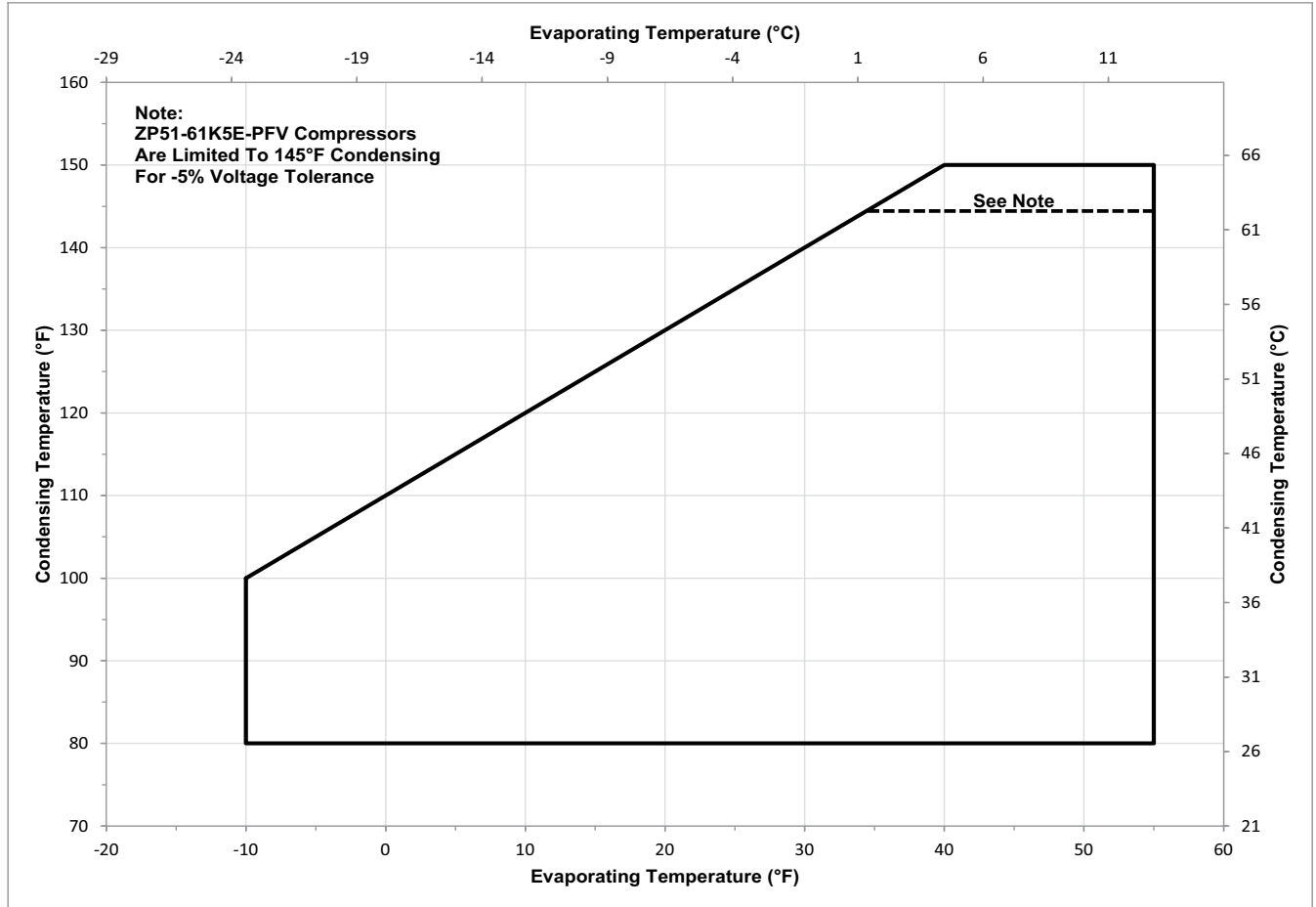

Figure 7 – R-410A Scroll Operating Envelope

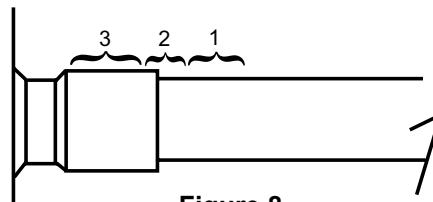

Figure 8
Scroll Suction Tube Brazing

New Installations

- The copper-coated steel suction tube on scroll compressors can be brazed in approximately the same manner as any copper tube.
- Recommended brazing materials: Any silfos material is recommended, preferably with a minimum of 5% silver. However, 0% silver is acceptable.
- Be sure suction tube fitting I.D. and suction tube O.D. are clean prior to assembly. If oil film is present wipe with denatured alcohol, Dichloro-Trifluoroethane or other suitable solvent.
- Using a double-tipped torch apply heat in Area 1. As tube approaches brazing temperature, move torch flame to Area 2.
- Heat Area 2 until braze temperature is attained, moving torch up and down and rotating around tube as necessary to heat tube evenly. Add braze material to the joint while moving torch around joint to flow braze material around circumference.
- After braze material flows around joint, move torch to heat Area 3. This will draw the braze material down into the joint. The time spent heating Area 3 should be minimal.
- As with any brazed joint, overheating may be detrimental to the final result.

Field Service



Remove refrigerant charge from both the low and high side of the compressor before cutting the suction and discharge lines to remove the compressor. Verify the charge has been completely removed with manifold gauges.

- To disconnect: Reclaim refrigerant from both the high and low side of the system. Cut tubing near compressor.
- To reconnect:
 - Recommended brazing materials: Silfos with minimum 5% silver or silver braze material with flux.
 - Insert tubing stubs into fitting and connect to the system with tubing connectors.
 - Follow **New Installation** brazing

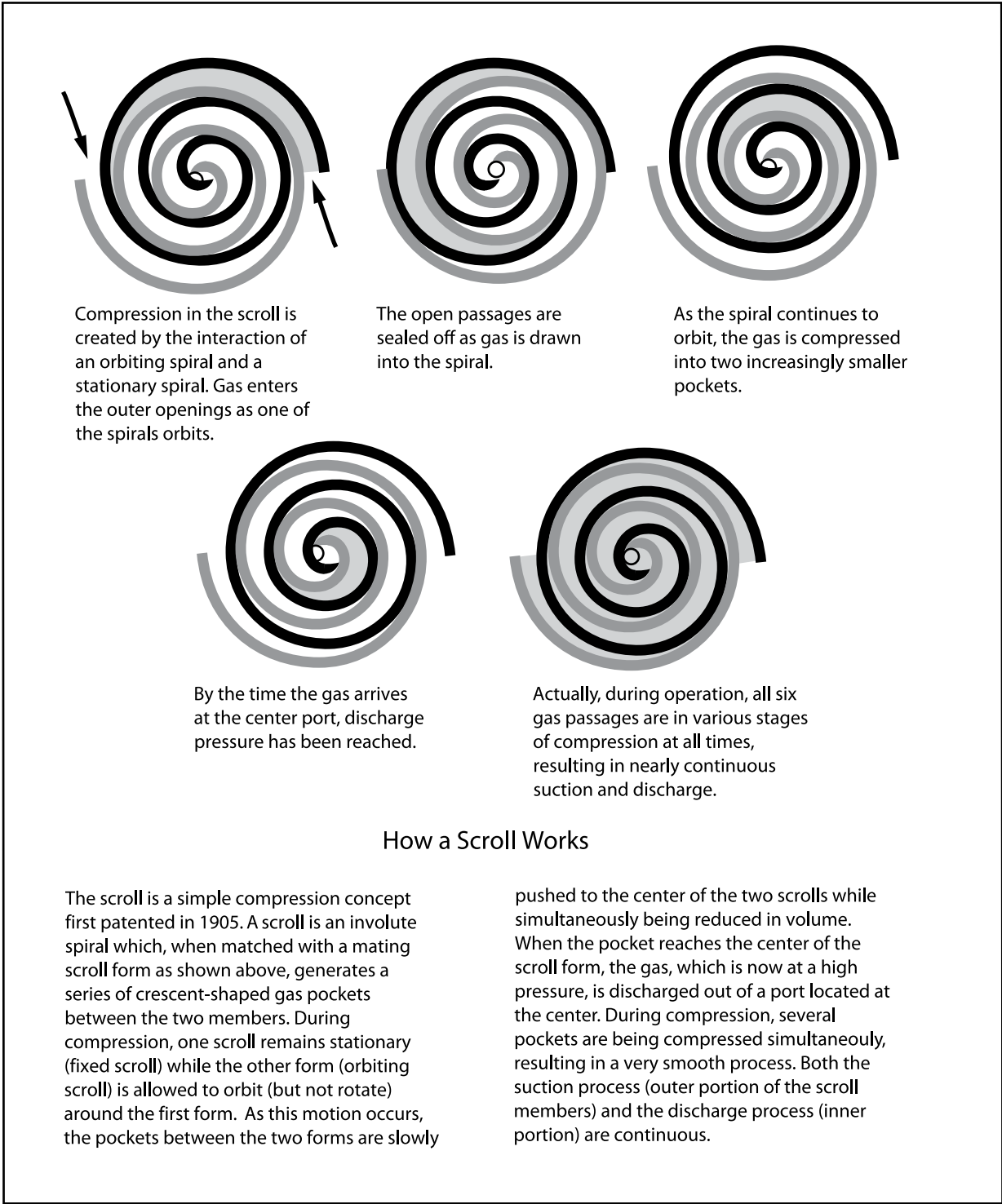

Figure 9

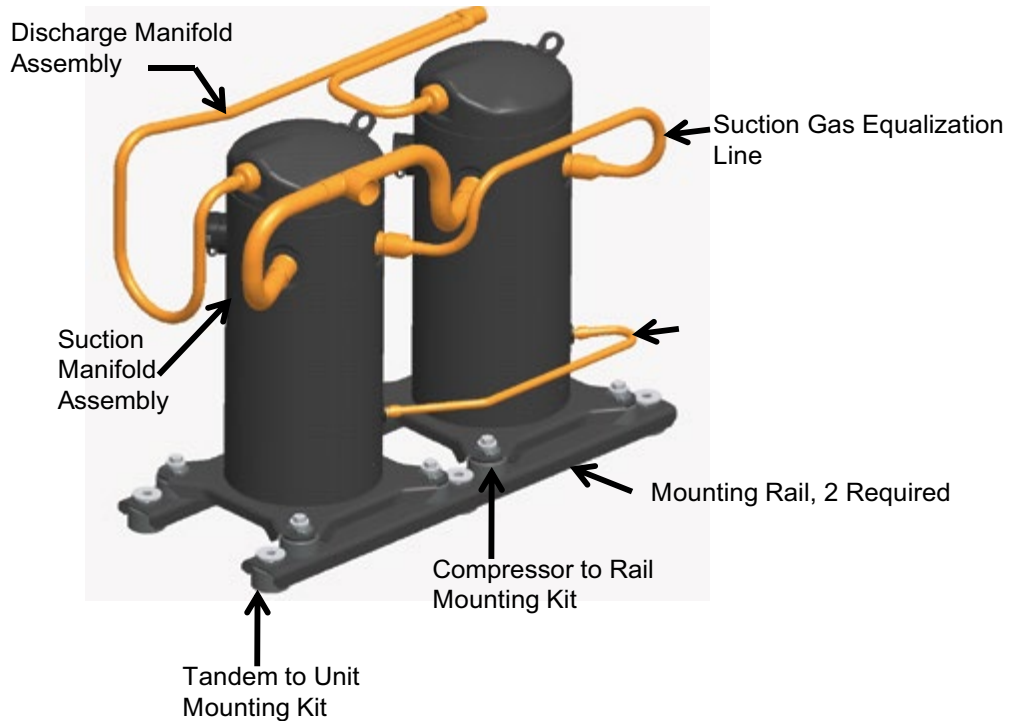

Figure 10
Typical ZPT*K5 Tandem

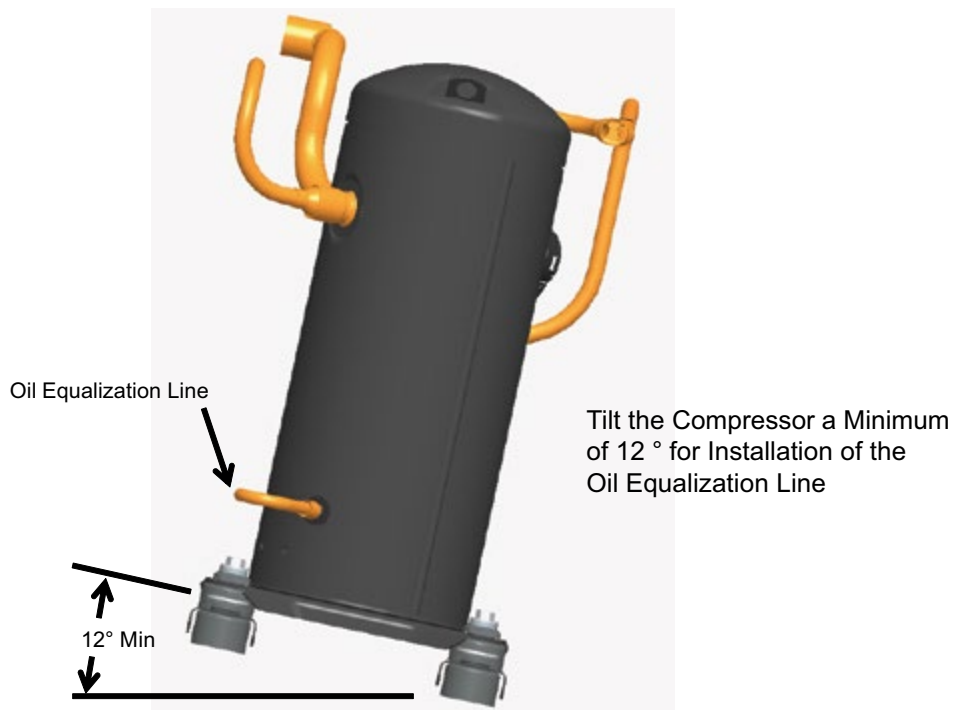

Figure 11
Tilted Tandem

Table 2
Field Application Test

Outdoor Ambient	85°F (29°C)	95°F (35°C)	105°F (40°C)
System On-Time (Minutes)	7	14	54
System Off-Time (Minutes)	13	8	6
Number of On/Off Cycles	5	5	4

Table 3
Design Configurations

Recommended Configuration	
Component	Description
Tubing Configuration	Shock loop
Service Valve	"Angled valve" fastened to unit
Suction muffler	Not required
Alternate Configuration	
Component	Description
Tubing Configuration	Shock loop
Service Valve	"Straight through" valve not fastened to unit
Mass / Suction muffler	May be required (Acts as dampening mass)

**Table 4
Compressor Accessories**

Part Category	Part Description	Part Number	Models	Notes
Mounting	Compressor Mounting Kit	527-0044-15	ZP14-31K5	30-35 Durometer
	Compressor Mounting Kit	527-0116-00	ZP34-61K5 ZP16-44K3	35-45 Durometer
	Spring Mounting Kit	527-0119-00	ZP34-61K5 ZP16-44K3	Caution: Tube Stress Must Be Evaluated
Crankcase Heater	Crankcase Heater, 120V, 40W	018-0094-01	ZP14-31K5	21" Leads
	Crankcase Heater, 240V, 40W	018-0094-00		21" Leads
	Crankcase Heater, 480V, 40W	018-0094-03		21" Leads
	Crankcase Heater, 120V, 40W	018-0096-01	ZP34-61K5 ZP16-44K3	21" Leads
	Crankcase Heater, 240V, 40W	018-0096-00		21" Leads
	Crankcase Heater, 480V, 40W	018-0096-02		21" Leads
	Crankcase Heater, 575V, 40W	018-0096-03		21" Leads
	Crankcase Heater, 240V, 40W	018-0096-04		48" Leads
	Crankcase Heater, 480V, 40W	018-0096-05		48" Leads
	Crankcase Heater Junction Box	998-7026-00		ZP34-61K5 ZP16-44K3
Electrical	Terminal Cover	005-1270-00	ZP16-44K3	
	Terminal Cover Gasket	020-0965-00	ZP16-44K3	
	Flag Terminal Kit	998-0021-00	ZP16-44K3	
	Grounding Screw	100-0605-00	All Models	10-32 x 8mm Long, Taptite Screw
	Molded Plug	529-0370-00	All Models	Universal Plug, 10 Gauge, 42" Leads
	Molded Plug Retainer Clip	032-0717-00	All Models	Optional Part, Locks the Molded Plug to Fence
	Flexible Metal Conduit Retainer	032-7051-01	All Models	Optional Part, Use with 032-0717-00
	Run Capacitor	Refer To Online Product Information At www.EmersonClimate.com For Model Specific Requirements		
	Start Capacitor			
	Start Relay			
SecureStart™	943-0120-00	ZP14-57K5 ZP16-44K3	1-Phase Only	
Diagnostics & Protection	CoreSense™ Diagnostics Module	971-0066-00	ZP14-61K5	2-Wire Module, 1-Phase Only
	CoreSense™ Diagnostics Module	971-0067-00		3-Wire Module, 1-Phase Only
	Comfort Alert™ Module	543-0010-01	All Models	2-Wire Module, 1-Phase Only
	Comfort Alert™ Module	543-0010-01	All Models	3-Wire Module, 1-Phase Only
	Comfort Alert™ Module	543-0032-00	All Models	1-Phase Only, Has "L" Terminal
	Comfort Alert™ Module	543-0038-02	All Models	3-Phase Only
	Comfort Alert™ Module	543-0067-00	All Models	1-Phase Only, Geothermal
	Discharge Line Thermostat	998-7022-02	All Models	Conduit Ready, fits 1/2" tube

Table 4 –Compressor Accessories (Continued)

Part Category	Part Description	Part Number	Models	Notes	
Suction & Discharge	Discharge Rotalock O-Ring Seal	020-0028-00	All Models		
	Suction Rotalock O-Ring Seal	020-0028-02	All Models		
	Rotalock Service Valve, Disc 1/2"	998-0510-98	All Models		
	Rotalock Service Valve, Suct 3/4"	998-0510-38	ZP14-31K5 ZP16-44K3		
	Rotalock Service Valve, Suct 7/8"	998-0510-90	ZP34-61K5		
	Disc Rotalock Adapter to 1/2" Sweat	998-0034-18	All Models		
	Suct Rotalock Adapter to 3/4" Sweat	998-0034-07	ZP14-31K5 ZP16-44K3		
	Suct Rotalock Adapter to 7/8" Sweat	998-0034-08	ZP34-61K5		
	1/2" Disc Stub Adapter to 1"-14 Rotalock	036-0538-00	All Models	Requires 020-0028-00 Seal	
	3/4" Suct Stub Adapter to 1-1/4"-12 Rotalock	998-0034-01	ZP14-31K5 ZP16-44K3		
	7/8" Suct Stub Adapter to 1-1/4"-12 Rotalock	998-0034-02	ZP34-61K5		
Tandems	Suction Manifold	528-2257-00	ZPT32-62K5	Not Available For Purchase From Emerson; Contact System OEM	
	Discharge Manifold	528-1571-00			
	Oil Equalization Tube	028-1162-00			
	Gas Equalization Manifold	028-1770-00			
	Suction Manifold	528-1572-00	ZPT88-122K5		
	Discharge Manifold	528-1978-00			
	Oil Equalization Tube	028-1162-00			
	Gas Equalization Manifold	028-1770-00			
	Tandem Mounting Kit, Compressor To Rails	527-0212-00	ZPT32-108K5		60-70 Durometer, 2 Kits Required
	Tandem Mounting Kit, Compressor To Rails	527-0181-00	ZPT114-122K5		Hard Mounting, 2 Kits Required
	Tandem Mounting Kit, Rails To Unit	527-0150-00	All Tandems		35-45 Durometer
	Tandem Rails	074-1235-00	All Tandems		2 Required

Table 5 – Compressor Refrigerant Charge Limits

Model	Frame Size*	Charge Limit		120% x Limit**		Tandem Charge Limit	
		Pounds	kg	Pounds	kg	Pounds	kg
ZP14 - 31K5	53	8	3.6	9.6	4.3	9.6	4.3
ZP34 - 61K5	63	10	4.5	12.0	5.4	12.0	5.4
ZP16 - 44K3	63	8	3.6	9.6	4.3		

*Approximate Shell Diameter (e.g. 63 - 6.5 Inches)

**Charge Allowance For System

The contents of this publication are presented for informational purposes only and are not to be construed as warranties or guarantees, express or implied, regarding the products or services described herein or their use or applicability. Emerson Climate Technologies, Inc. and/or its affiliates (collectively "Emerson"), as applicable, reserve the right to modify the design or specifications of such products at any time without notice. Emerson does not assume responsibility for the selection, use or maintenance of any product. Responsibility for proper selection, use and maintenance of any Emerson product remains solely with the purchaser or end user.