

Large ZX Condensing Unit

User Manual



COPELAND™

Table of contents

Introduction	3
Safety Information	4
Nomenclature	6
Scope of Supply	6
PI Diagram	7
Technical Data	9
Features & Benefits	10
Condensing Unit Layout	12
CoreSense Controller	13
Networking	18
Electrical Connections	20
Installation, System Processing, & Start-up	21
Troubleshooting	28
System Start-up & Operational Check Sheet	39

Introduction

Thank you for purchasing the Copeland™ Large ZX Condensing Unit for refrigeration applications. This unit comes with a high efficiency Copeland fixed speed scroll compressor with liquid / vapor injection technology.

This is the best-in-class unit available in the market within the capacity and operating range.

Copeland condensing units have been highly successful in global market and enjoys proven success with its energy savings and customer friendly electronic features.

This document is designed to help the contractor and customer with the installation, commissioning & operation of the Copeland Large ZX Condensing Unit.

Disclaimer

Please read through this operation manual to familiarize yourself with the installation, commissioning, and operation of this product. Please do read the following information on this page before proceeding with the rest of the user manual.

Copeland Large ZX scroll refrigeration condensing units should only be installed by suitably qualified and experienced refrigeration technicians. No responsibility can be accepted for damage caused by inexperienced or inadequately trained site technicians or improper system design. All instructions and procedures described in this manual are based on good refrigeration trade practices as applicable to this particular product. The installation contractor may prefer to use variations to these recommendations. However, the methods described in this manual represent the minimum requirements to avoid any subsequent warranty claims for this equipment and its components. These instructions do not cover the fundamentals of good electrical or refrigeration practice and are therefore intended for use only by qualified and/or experienced personnel or technicians.







For additional inquiries, please consult your local sales office, quoting unit model and serial number as shown on the nameplate. In case of ambiguity, the wiring diagram supplied with each unit takes precedence over the diagram in this user manual.

1. Safety Information

1.1 Installation and commissioning work on CDU shall be carried out only by qualified, refrigeration personnel who have been trained and instructed.

1.2 Copeland Large ZX condensing unit is manufactured according to the latest safety standards. Emphasis has been placed on the user's safety. For relevant standards please refer to the manufacturer's declaration, available on request. You are strongly advised to follow these safety instructions.

1.3 Icon explanation

 WARNING This icon indicates instructions to avoid personal injury and material damage.	 CAUTION This icon indicates instructions to avoid property damage and possible personal injury
 High Voltage This icon indicates operations with a danger of electric shock	 IMPORTANT This icon indicates instructions to avoid malfunction of the compressor
 Danger of burning or frostbite This icon indicates operations with a danger of burning or frostbite	NOTE This word indicates a recommendation for easier operation
 Explosion hazard This icon indicates operations with a danger of explosion	

1.4 Safety Statements

- a. Only qualified and authorized refrigeration personnel are permitted to install, commission, and maintain this equipment.
- b. Electrical connections must be made by qualified electrical personnel.
- c. All valid standards for connecting electrical and refrigeration equipment must be observed.
- d. The national legislation and regulations regarding personnel protection must be observed.



Use personal safety equipment. Safety goggles, gloves, protective clothing, safety boots and hard hats should be worn where necessary.

1.4 General Instructions



Warning

System breakdown! Personal Injuries! Never install a system in the field and leave it unattended when it has no charge, a holding charge, or with the service valves closed without electrically locking out the system.



Warning

High shell temperature! Burning! Do not touch the compressor until it has cooled down. Ensure that the other materials in the area of the compressor do not get in touch with it. Lock and mark accessible sections.



Caution

Overheating! Bearing damage! Do not operate compressors without refrigerant charge or without being connected to the system.



Caution

Compressors contain oil & refrigerant under pressure. Release pressure from both high & low side of compressor before servicing.



Caution

Tube brazing and compressor operation can produce hot surfaces. To avoid burns, allow surfaces to cool.

1.6 Safety Refrigerants/Lubricant

- a. Please use correct refrigerant as designed to work in safe operating envelope
- b. Compressor is supplied with an initial oil charge. The standard oil charge for use with HFC refrigerant is Polyolester Oil (POE) lubricant Emkarate RL 32 - 3MAF.

1.7 Receiving your unit

All units are filled with an ideal gas at a positive pressure before transportation. When you receive the unit from Emerson or an authorized representative, it is important to check the pressure of each unit. If the unit is found without any pressure on receipt, please contact Copeland or their authorized distributor. Damage to the unit caused by the transportation / handling should fall within the category of insurance claims and not be a manufacturing defect. It is also advisable to inspect the rest of the unit for any physical damage and inform Copeland or authorized distributor.

2. Nomenclature

ZX	L	012	B	E	-	TFM	-	551
Condensing unit family	Blank = Medium Temp L = Low Temp	MT: 9 - 15 HP LT: 10 - 20 HP	Generation	E = Polyolester oil		TFM = 380V/420V, 3ph, 50 Hz		Bill of Material
Base model						Electrical Code		Bill of Material

3. Scope of Supply

Large ZX / Scroll Rack Model	ZX (9 - 15HP)	ZXLD
BOM	551	551
Liquid Line Filter Drier	✓	✓
Moisture Indicator	✓	✓
Oil Separator	✓	✓
Accumulator		✓
Adjustable LP Control Switch	✓	✓
Fixed LP Safety Switch	✓	
Fixed HP Safety Switch	✓	✓
CoreSense Protection	✓	✓
Intelligent store ready	✓	✓
Fan speed controller	✓	✓
Circuit breaker	✓	✓
Compressor Sound Jacket	✓	✓
Receiver certification (UL/PED)	✓	✓
Pressure Relief Valve	✓	✓

4. PI Diagram

ZX

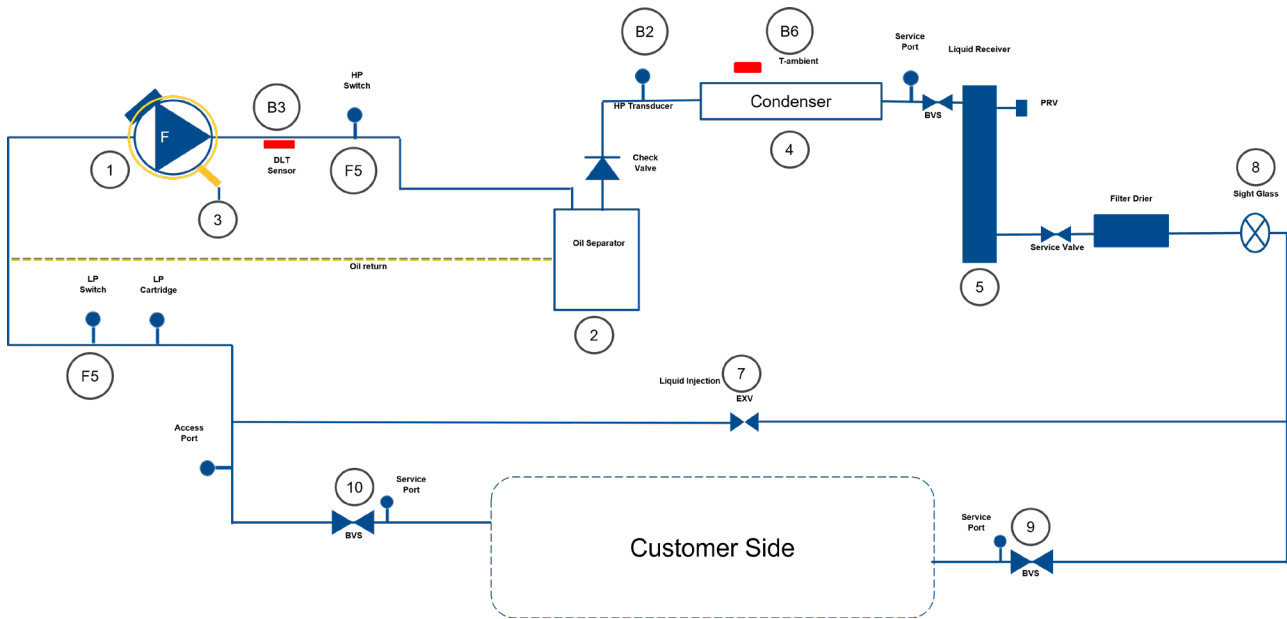

Position	Description
1	Compressor M1
2	Oil Seperator
3	Crank Case Heater R2
4	Condenser
5	Receiver
6	—
7	Electronic Expansion Valve
8	Filter Drier / Sight Glass
9	Ball Valve, Liquid line

Position	Description
10	Ball Valve, Suction line
11	—
F5	Adjustable LP/HP Dual Pressure Switch
B2	Pressure Transmitter, HP
B3	Discharge Line Temperature Sensor
B4	—
B5	—
B6	Ambient Temperature Sensor

ZXL with EVI Technology

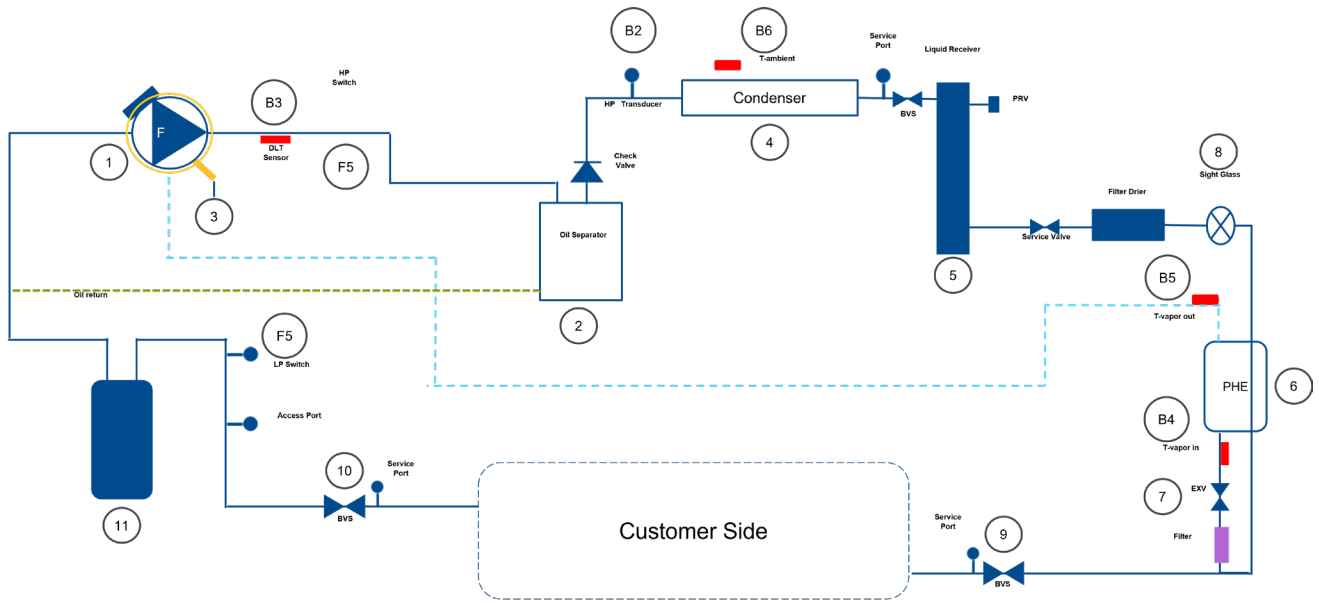

Position	Description
1	Compressor M1
2	Oil Seperator
3	Crank Case Heater R2
4	Condenser
5	Receiver
6	Brazed Plate Economizer
7	Electronic Expansion Valve
8	Filter Drier / Sight Glass
9	Ball Valve, Liquid line

Position	Description
10	Ball Valve, Suction line
11	Accumulator
F5	Adjustable LP/HP Dual Pressure Switch
B2	Pressure Transmitter, HP
B3	Discharge Line Temperature Sensor
B4	Vapour In Temperature Sensor
B5	Vapour Out Temperature Sensor
B6	Ambient Temperature Sensor

5. Models

Medium temperature, 9 - 15HP

Family				ZX			
Nominal Rating		Horsepower	HP	9	10	13	15
Model name				ZX090BE	ZX100BE	ZX130BE	ZX150BE
Unit Performance	Sound Pressure Level	@ 1m	dB(A)	60 / 66	60 / 66	61 / 67	64 / 67
Compressor	Rated Load Ampere		amp	17.5	20.0	25.0	27.9
	Locked Rotor Ampere		amp	111	118	140	174
	Oil Type			POE			
	Oil Recharge Volume			3.14			
Fan Motor	Number of Fans		Unit	1			
	Diameter		mm	710			
	Maximum Speed		rpm	1010			
	Air Flow	Total	m ³ /h	16632	16632	15372	15372
	Total Fan Motor Power	Input	W	855	855	980	980
Others	Oil Separator	Volume	liters	0.6			
	Receiver Volume		kg	17			
	Pipes	Suction OD	inch	1 3/8"			
		Liquid OD	inch	3/4"			
	Dimension	W x H x D	mm	1200 x 882 x 2044			
	Weight	Net	kg	308	310	316	318
		Gross	kg	373	375	381	383

Low temperature, 10 - 20HP

Family				ZXL			
Nominal Rating		Horsepower	HP	10	13	15	20
Model name				ZXL100BE	ZXL130BE	ZXL150BE	ZXL200BE
Unit Performance	Sound Pressure Level	@ 1m	dB(A)	61 / 67	64 / 69	64 / 69	70 / 71
Compressor	Rated Load Ampere		amp	21.7	23.0	23.0	28.6
	Locked Rotor Ampere		amp	118	118	139	168
	Oil Type			POE			
	Oil Recharge Volume			3.25 vvv			
Fan Motor	Number of Fans		Unit	1			
	Diameter		mm	710			
	Maximum Speed		rpm	1010			
	Air Flow	Total	m ³ /h	16632	16632	15372	15372
	Total Fan Motor Power	Input	W	855	855	980	980
Others	Oil Separator	Volume	liters	0.6			
	Receiver Volume		kg	17			
	Pipes	Suction OD	inch	1 3/8"			
		Liquid OD	inch	3/4"			
	Dimension	W x H x D	mm	1200 x 882 x 2044			
	Weight	Net	kg	334	334	340	340
		Gross	kg	399	399	405	405

6. Features & Benefits

Large ZX platform condensing units were designed based on demands by industry users:

Energy efficiency - Utilizing Copeland™ scroll compressor technology, variable speed fan motor, large capacity condenser coil and advanced control algorithms, energy consumption is significantly reduced. End-users can save more than 20% on annual energy costs compared to equivalent reciprocating units.

Reliability - Combining the proven reliability of Copeland scroll compressors with advanced electronics controller and diagnostics, equipment reliability is greatly enhanced. Fault code alerts and fault code retrieval capabilities provide information to help improve speed and accuracy of system diagnostics. Integrated electronics provide protection against over-current, over-heating, incorrect phase rotation, compressor cycling, high pressure resets, low pressure cut-outs. It can also send out a warning message to an operator when there is liquid flood back, which can prevent critical damage on the unit.



Condensing Unit Features

Copeland™ scroll compressor technology

Highly efficient, ultra-quiet and highly reliable.

Configured with CoreSense controller

Provides electronic diagnosis, protection, and communication modules for energy-saving and reliable unit control. Provides digital modulation control.

Enhanced vapor injection (ZXL only)

Vapor injection provide high efficiency for refrigeration application

Well-tuned electronics algorithm with one big PHE to sub-cool the liquid temperature, and feed gas into the compressors' EVI ports.

Design Features

- Real-time monitoring of compressor operating conditions
- Compressor reverse rotation protection
- Compressor over current protection
- Compressor internal motor protector
- Discharge gas overheat protection
- Over voltage protection
- Under voltage protection
- High pressure protection
- Low pressure protection
- Refrigerant flood back warning
- Compressor minimum off time
- Compressor oil level protection
- Intelligent store Solution: Communication and retail store monitoring

7. Condensing Unit Layout

9 - 15 HP Unit

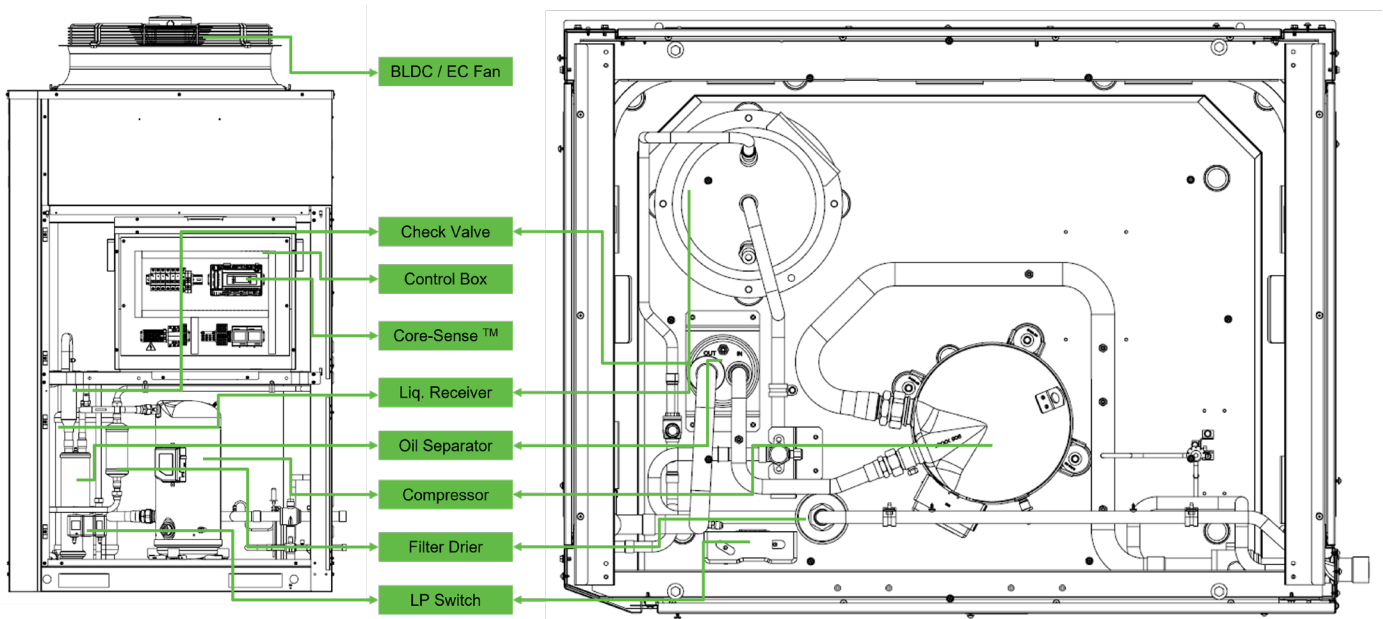

10 - 20 HP Unit

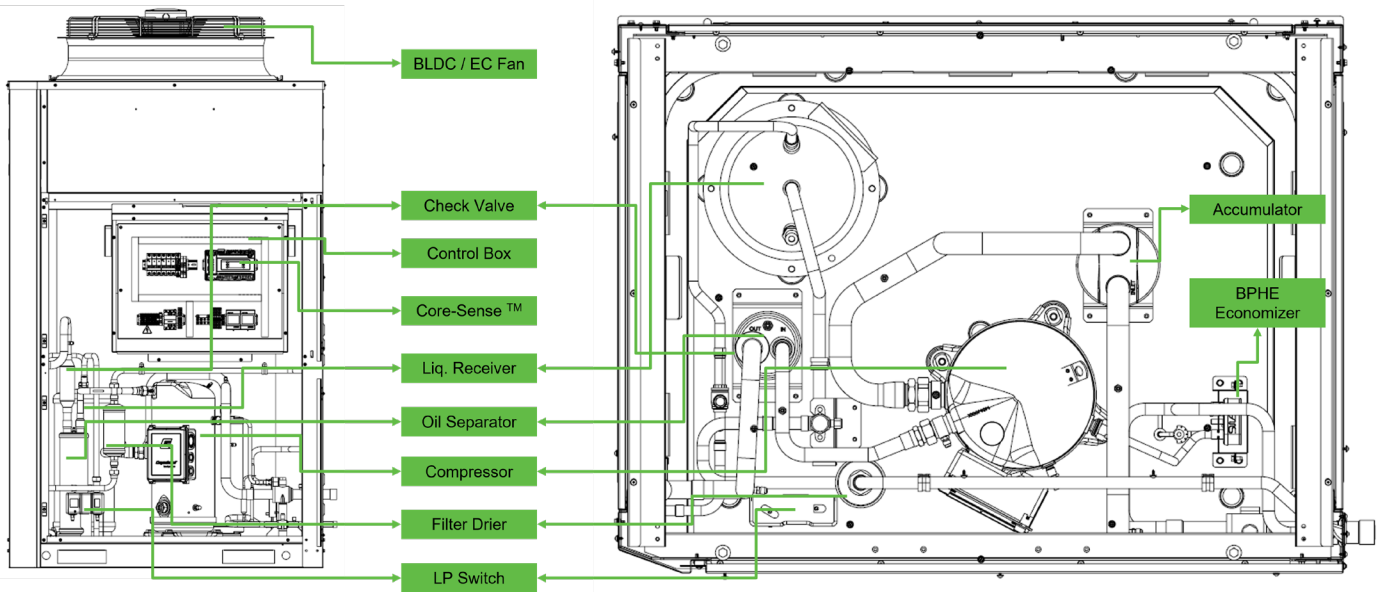

8. CoreSense Controller

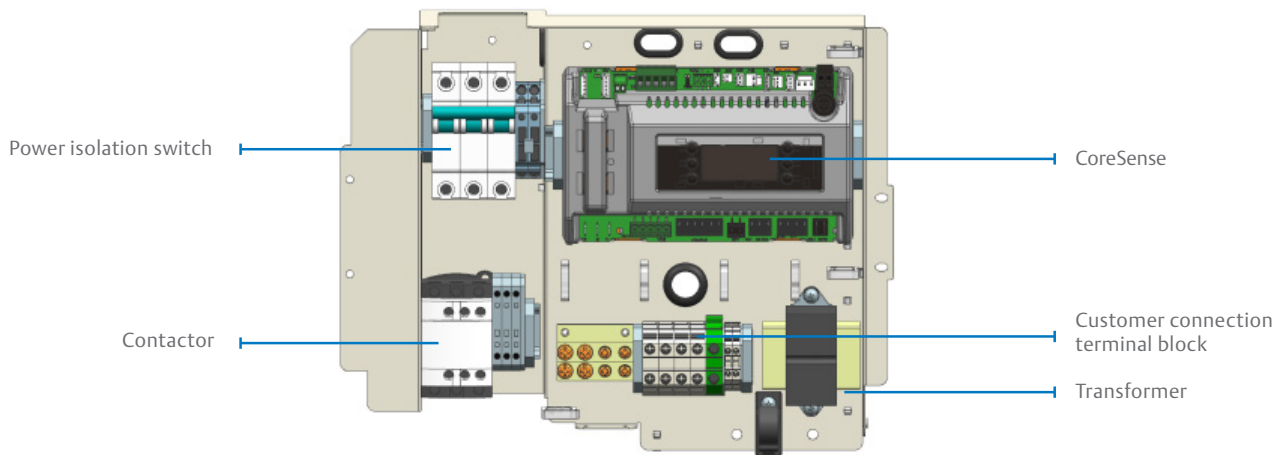

CoreSense Layout

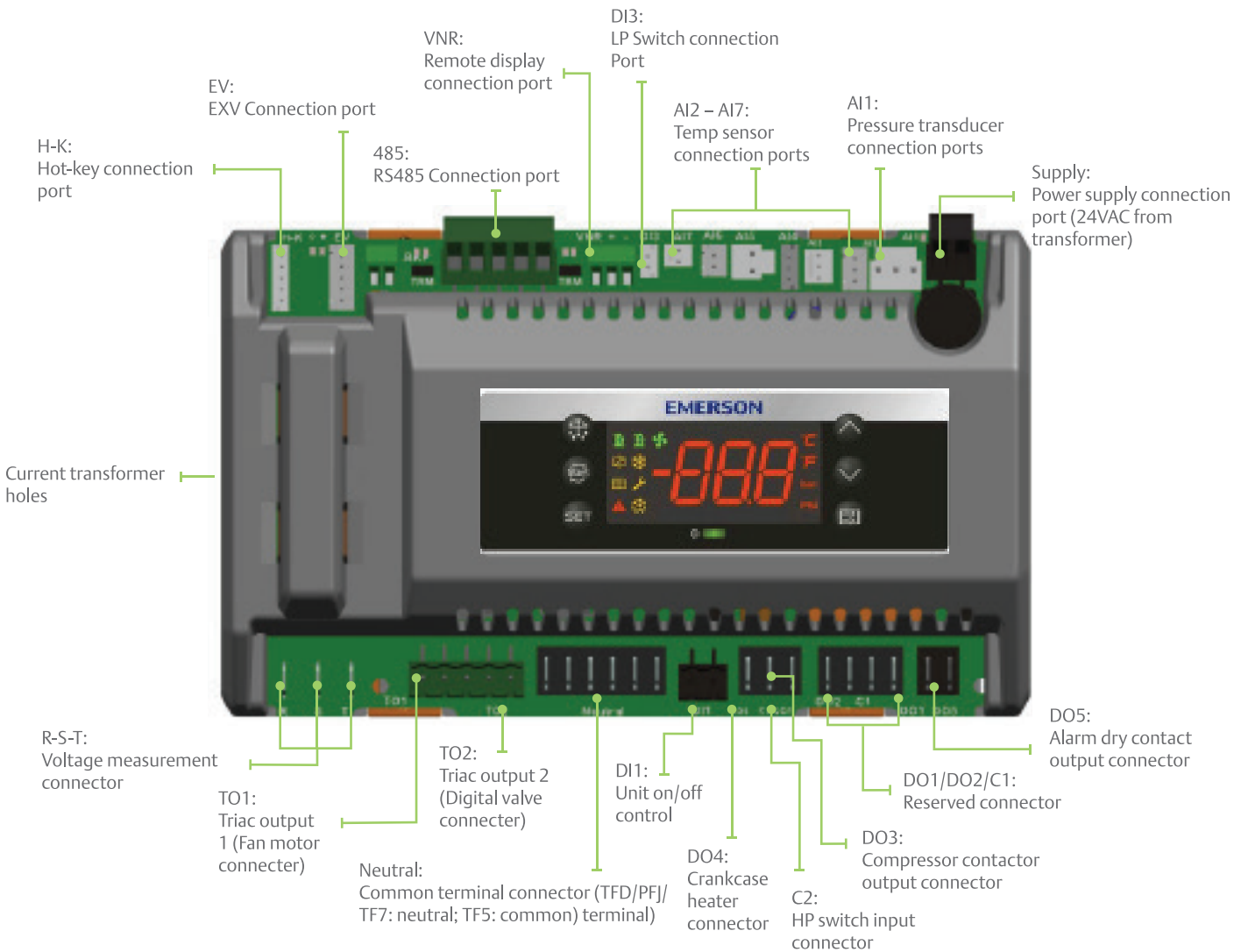



LED descriptions

LED	Status	Description
	ON	Compressor1 is running
	Flashing	Compressor1 is ready to start
	ON	Reserved
	Flashing	Reserved
	ON	Condensing fan is running
	ON	Reserved
	ON	Display with °C
	Flashing	Programmable mode

LED	Status	Description
	ON	Browsing the service menu
	Flashing	Browsing the fast access menu
	ON	A new alarm happened
	Flashing	Browsing the alarm menu
	ON	An alarm is occurring
	ON	Reserved
	-	Reserved

Keyboard descriptions - single button

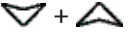
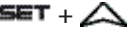
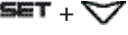
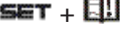

	Set	Display target set point; In programming mode, select a parameter or confirm an operation.
	Reset	Hold for 5 seconds to reset any lockouts if the current state of the controller allows for it to be reset.
	Up	Enter the fast access menu; In programming mode, browse the parameter codes or increases the displayed value.
	Down	In programming mode it browses the parameter codes or decreases the displayed value.
	Service	Enter the service and alarm menu.
	Defrost	Hold for 3 seconds to start a manual defrost or terminate an active defrost. (Not available at the moment).

Keyboard descriptions - combined buttons







	Press and hold for about 3 seconds to lock (Pon) or unlock (PoF) the keyboard.
	Pressed together to exit programming mode or menu; under rtC and Par, this combination allows the user to go back to previous level.
	Pressed together for 3 seconds allows access to first level of programming mode.
	Pressed together for 3 seconds allows access to EXV manual setting.

Controller initialization message



When the unit is initially powered on, the controller will display the following.

Step	Action	Phenomenon and description
1	Power on controller	All LEDs will light up for 3 seconds.
2		Firmware version will be displayed for 3 seconds.
3		Parameter setting file (bin file number) identifier will be displayed for 3 seconds.
4		Normal display (actual suction temperature will be displayed on ZXV/ZXD unit, condensing temperature will be displayed on ZX/ZXL/ZXB unit)





Pr1 parameter (1st level) Browse and Modification

Step	Action	Phenomenon and description
1	Press "SET" + 	Enter menu to select "PAR" (parameter) or "rtC"
2	Press  or 	Select "rtC"
3	Press "SET"	"n01", minute "n02", hour "n03", day "n04", month "n05", year (last two digits)
4	Press "SET"	Display actual value
5	Press  or 	Modify the value
6	Press "SET"	Press "SET" : the value will flash for 3 seconds, then move to the next value
7	Press "SET" + 	Exit to "rtC"
8	Press "SET" + 	Exit to main menu (or wait for 120 seconds and exit automatically)













Quick access menu browse - sensors status and actual values

Step	Action	Phenomenon and description
1	Press " 	Enter quick access menu, will display "P1P" (Press "Up" or "Down" to view other sensors)
2	Press " SET "	View the actual value of "P1P"
3	Press " SET "	Change to next sensor code
4	Press " SET " + " 	Exit (or exit automatically after waiting for 60 seconds)
<p>Sensor code and values descriptions ("nP", "noP", or "nA" mean that the sensor does not exist; "Err" means that the sensor fails, out of range, disconnected, or does not configure correctly)</p>		<ul style="list-style-type: none"> • P1P : Pressure value of suction (only in ZXD & ZXV) • P2t : Temperature value of condenser mid coil • P2P : Pressure value of discharge (not used) • P3 : Discharge line temperature • P4 : PHE vapor inlet temperature sensor • P5 : PHE vapor outlet temperature sensor • P6 : Ambient temperature sensor • P7 : Not used • SH : PHE superheat • oPP : EXV opening step • LLS : Status of the liquid line solenoid valve • Std : Condensing temperature setting point • Aoo : Percentage of the analog output • dSo : Percentage of the PWM output driving the valve of the digital scroll compressor • Lt : Minimum room temperature • Ht : Maximum room temperature • HM : Time Menu (hour & minute)

Access alarm code (maximum of 50 record)

Step	Action	Phenomenon and description
1	Press " 	Display "SEC"
2	Press " SET "	Display "A01"
3	Press " 	Display alarm code in "A01"
4	Press " 	Display "A02"
5	Press " 	Display alarm code in "A02"
6	...	
7	Press " SET " + " 	Exit (or exit automatically after waiting for 15 seconds)

Exact timing of the alarm

Step	Action	Phenomenon and description
1	Press "  "	Display "SEC"
2	Press " SET "	Display "A01"
3	Press "  "	Display alarm code in "A01"
4	Press " SET "	Display "Hr"
5	Press "  "	Display the alarm exact timing: hour
6	Press "  "	Display "Min"
7	Press "  "	Display the alarm exact timing: minute
8	Press "  "	Display "Day"
9	Press "  "	Display the alarm exact timing: day
10	Press "  "	Display "Mon"
11	Press "  "	Display the alarm exact timing: month
12	Press "  "	Display "yEA"
13	Press "  "	Display the alarm exact timing: year
14	Press " SET " + "  "	Exit (or exit automatically after waiting for 15 seconds)

Upload the program from the controller to hot-key

Step	Action	Phenomenon and description
1	Inert Hot-Key when the controller is ON	
2	Press "  "	the "uPL" message appears followed by a flashing "End" label (Note: if display "Err", it means it fails to upload program to Hot-Key. Please restart the process.)
3	Press " SET "	"End" will stop flashing
4	Turn-off the controller and remove Hot-Key	
5	Turn-on the controller	

Download the program from hot-key to controller

Step	Action	Phenomenon and description
1	Turn-off the controller	
2	Insert hot-key	
3	Turn-on the controller	The "doL" message will blink followed a by a flashing "End" label (Note: if display "Err", it means it fails to download program to the controller. Please restart the process.)
4		Controller will restart working with the new parameters after 10 seconds
5	Remove hot-key	

9. Networking

Dixell XWEBPRO serial address - Wiring

- Connect to the ModBUS network using cable with 2 or 3 shielded wires, minimum section 0.5mm^2 (e.g. BELDEN8772)
- Do not connect shield to ground.
- Do not connect the “Gnd” terminal.
- Remember to draw a map of the line. This will help you to find an error if something is wrong.
- RS485 devices are polarity sensitive.

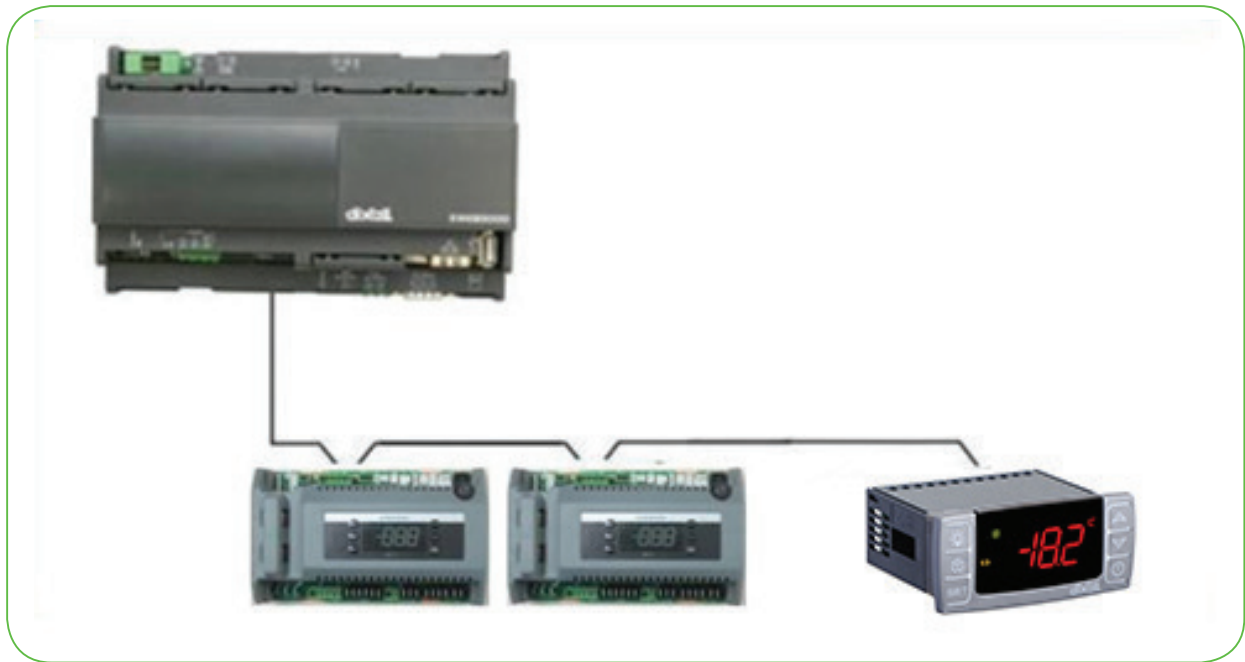

Correct network wiring

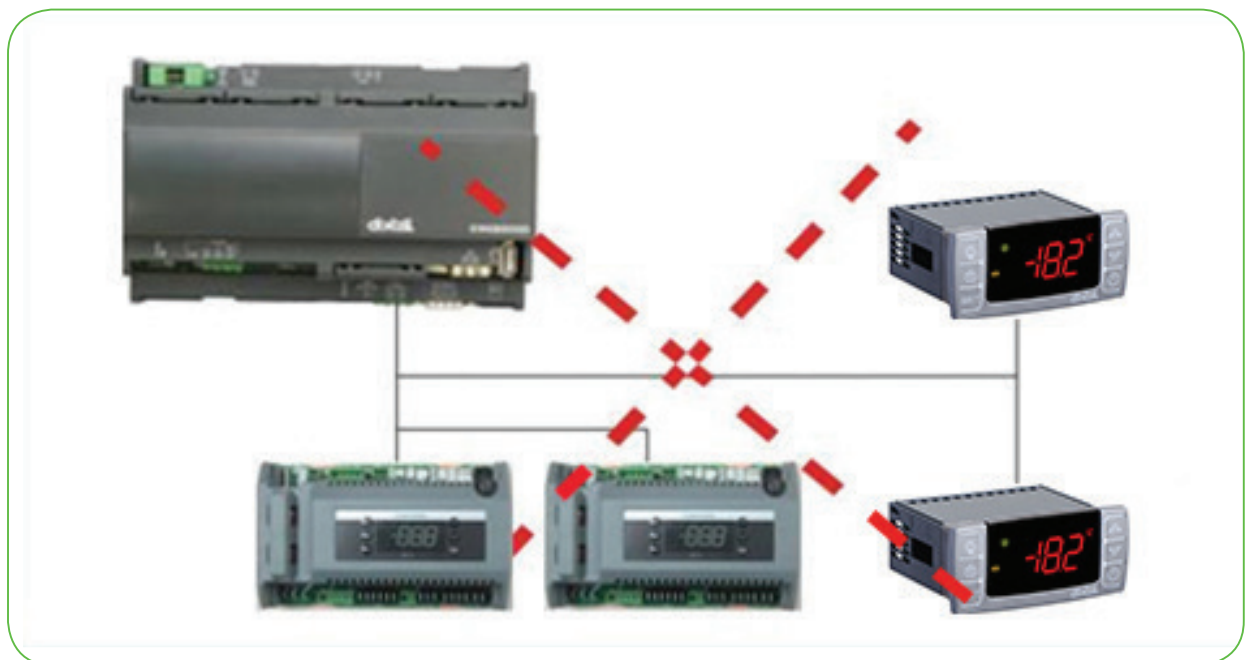

Incorrect network wiring

ZX CDU connected to XWEBPRO

ZX CDU connected to the Dixell XWEBPRO with the Intelligent Store solution module using RS485 ModBUS.

Connect the ZX CDU to the ModBUS network as shown below. Connect the network cable to the three-terminal connector on the XWEB port that has been configured as ModBUS port (COM 12, 13, 14).

Connect port “13” of XWEBPRO to port “D0485 +” of CoreSense™ and port “12” of XWEB300D to port “D1485 -” of CoreSense for RS485 communication.

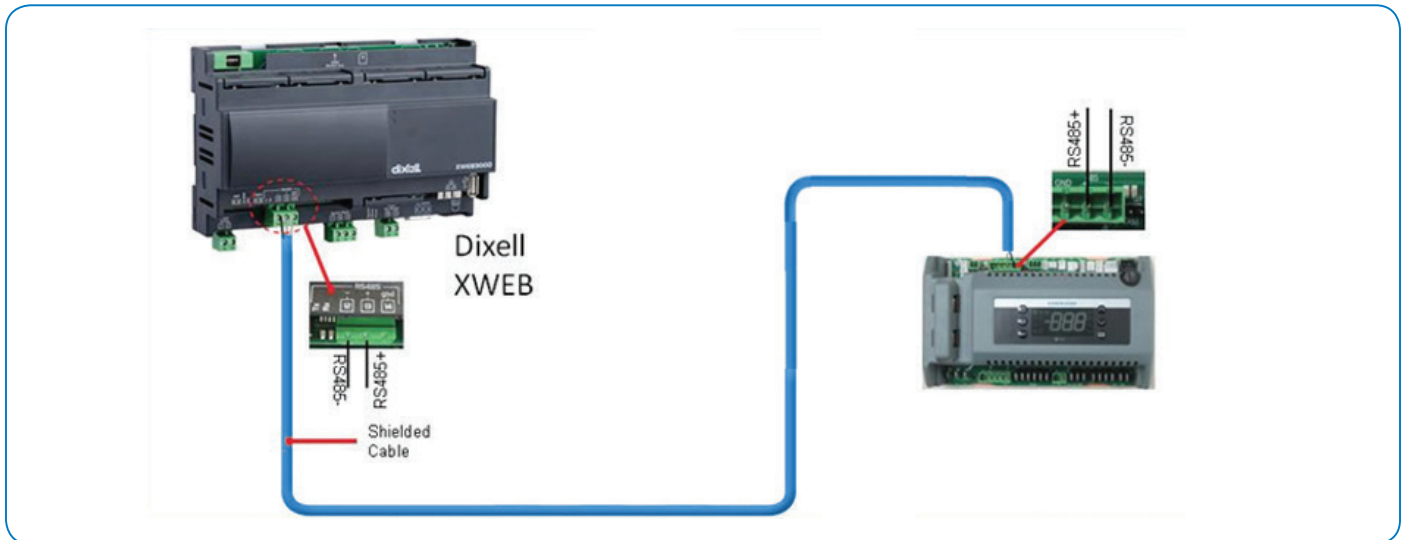

XWEB300D Connected to the Intelligent Store Solution Module

11. Electrical Connections

ZX/ZXL-TFM Condensing Unit Electrical Wiring Diagram

TFM : 380/420V, 50Hz, 3Ph + N

NOTES:
 1. Dashed Line " " is wired by installer.
 2. The inclusion of OW4 and TF2 are BOM specific.
 3. Earth "E" wire termination not shown for clarity.
 052-3838-00
 04/14/2022

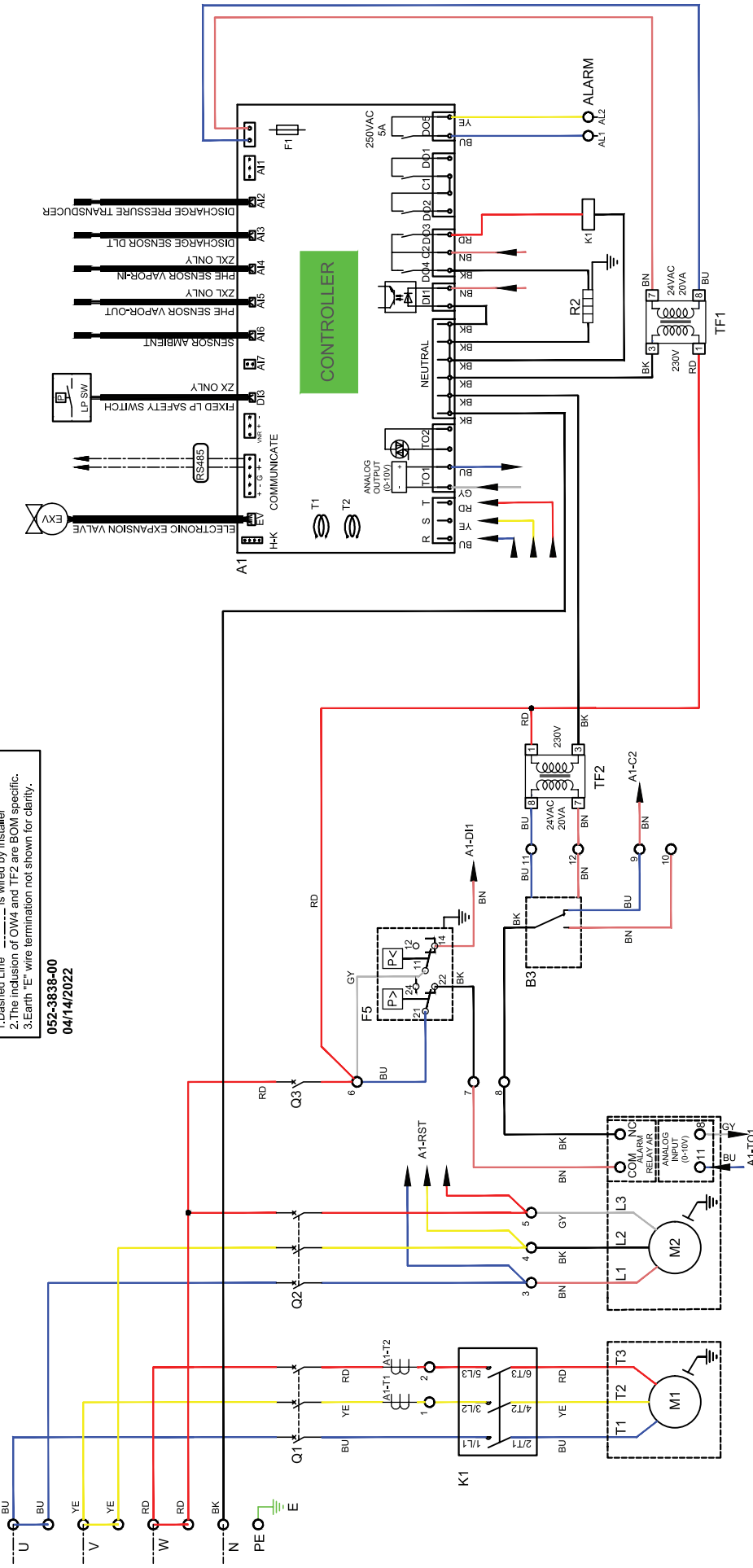

DESCRIPTION	LEGEND	DESCRIPTION	LEGEND
CONTROLLER	A1	FAN MOTOR	M2
OIL LEVEL MONITOR,OW4	B3	CIRCUIT BREAKER	Q1,Q2,Q3
HIGH/LOW PRESSURE SWITCH	F5	CRANKCASE HEATER	R2
COMPRESSOR CONTACTOR	K1	TRANSFORMER,CONTROLLER	TF1
COMPRESSOR MOTOR	M1	TRANSFORMER,OW4	TF2

CABLE COLOUR	LEGEND
BLUE	BU
BLACK	BK
BROWN	BN
YELLOW	YE
RED	RD
GREY	GY

11. Installation, System Processing and Commissioning

Utmost care must be taken while handling the Large ZX condensing unit. Please go through the contents below to ensure proper handling.

11.1 Location and Fixing

Large ZX should always be installed in a location that ensures clean air flow. The minimum operating space for unit is described in below figure. Both service access and airflow have been considered in making these recommendations. Where multiple units are to be installed in the same location, the contractor needs to consider each individual case carefully. There can be many variations of unit quantities and available space and it is not the intention of this manual to go over these. Ideally, the unit should be mounted on a solid concrete slab with anti-vibration pads between unit feet and concrete.

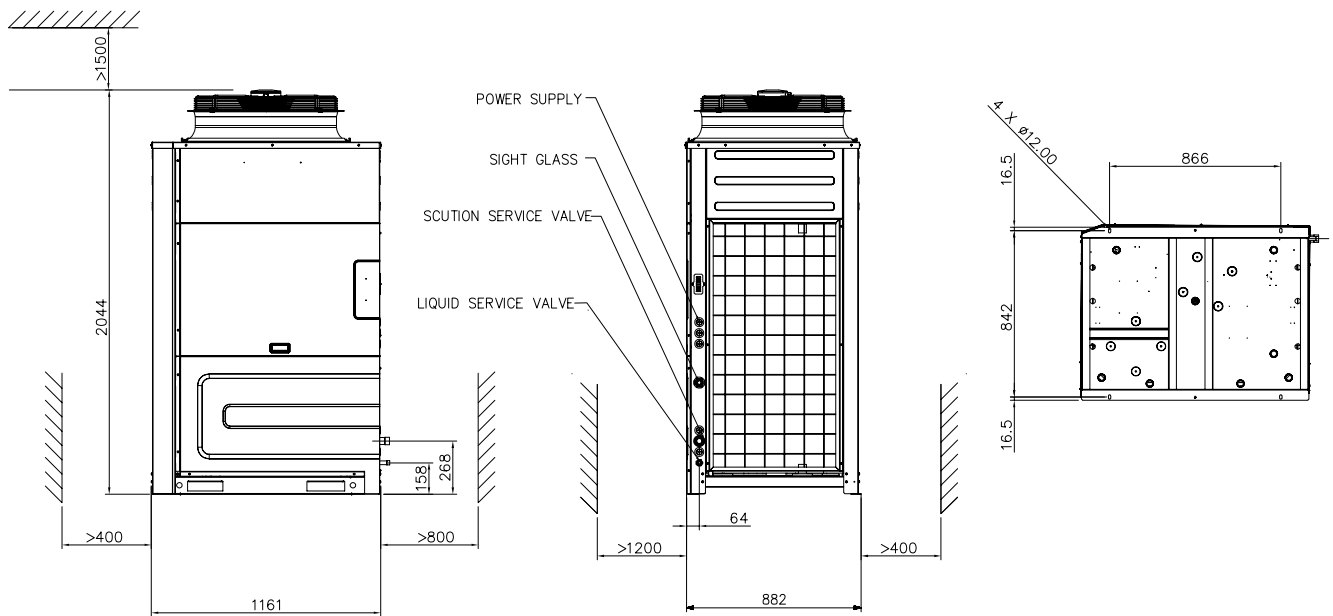

11.2 Refrigeration Piping Installation

All interconnecting pipes should be of refrigeration grade, clean, dehydrated and must remain capped at both ends until installation. Even during installation, if the system is left for any reasonable period (say two hours), pipes should be re-capped to prevent moisture and contaminants from entering the system.

Do not assume that the service connection sizes on the unit (at the service valves) are the correct size to run your interconnecting refrigeration pipes. The service valve sizes have been selected for convenience of installation and in some cases (larger units) these may be considered too small. However, for the very short pipe run within our units, these service connection sizes are adequate.

The pipe should be sized to ensure optimum performance and proper oil return. The sizing must also consider the full capacity range through which this particular unit will need to operate.

Pipe runs should be kept as short as possible, using the minimum number of directional changes. Use large radius bends and avoid trapping of oil and refrigerant. This is particularly important for the suction line. The suction line should ideally slope gently towards the unit. Recommendation slope is 1/200 ~ 1/250. P traps, double risers and reduced pipe diameters may be required for suction lines where long vertical risers cannot be avoided. All pipes should be adequately supported to prevent sagging which can create oil traps.

Tube size	Max distance between 2 clamp support
12.7mm (1/2 inch)	1.20 m
16.0mm (5/8 inch)	1.50 m
22.0mm (7/8 inch)	1.00 m
28.5mm (1 1/8 inch)	1.00 m
41.28mm (1 5/8 inch)	2.70 m

11.3 Refrigerant line insulation

1. Insulate suction lines from the evaporators to the condensing unit with minimum 1" thickness closed-cell type insulation on low temperature circuits.
2. Liquid lines of vapour injection (ZXL unit) to be minimum of 3/4" insulation.
3. Suction and liquid lines should never be taped or soldered together.

11.4 Electrical

1. All electrical work must be done in accordance with the National Electrical Code and existing local codes.
2. Power supply must be the same as specified on the unit's name plate.
3. Voltage fluctuations in excess of 10 percent must be corrected.
4. Before starting the unit, ensure that all protective devices are in place and that all wiring is secure.

11.5 Brazing Recommendation

Maintain a flow of oxygen-free nitrogen through the system at a very low pressure during brazing. Nitrogen displaces the air and prevents the formation of copper oxides in the system. If copper oxidization is allowed to form, the copper oxide material can later be swept through the system and block screens such as those protecting capillary tubes, thermal expansion valves, and accumulator oil return holes. This minimizes any entry of contaminants and moisture.

- Remove the liquid line connection cap.
- Then remove the suction connection cap.
- Open both valves midway.
- Care should be taken to avoid the holding charge from releasing too quickly.
- Be sure tube fitting inner diameter and tube outer diameter are clean prior to assembly.
- Since both tubes are extended from the condensing unit housing, we recommend insulating the housing by using a wet cloth on the copper tubing.
- Recommended brazing materials: a copper / phosphorous or copper phosphorous / silver alloy rod should be used for joining copper to copper whereas to join dissimilar or ferric metals, use a silver alloy rod, either flux coated or with a separate.
- Use a double tip torch.

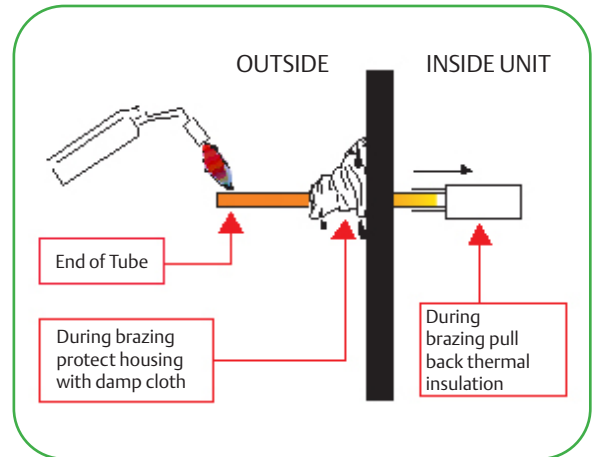

11.6 Expansion Valve Selection Consideration

As the Large ZXL units are with vapour injection compressors, (except the ZX units), need to consider subcooled liquid temperature while selecting the expansion valve as given below.

Evaporation temperature °C	Standard supply temperature °C						R404A
	Ambient temperature °C						
	20	27	32	38	43	48	
-40	-8	-1	3	8	13	19	
-35	-4	2	6	11	15	21	
-30	0	6	9	13	18	23	
-25	5	10	13	17	21	26	
-20	9	14	17	20	24	30	
-15	13	18	21	24	28	34	
-10	18	23	27	32	36	-	
-5	21	27	31	27	42	-	

11.6 Start-up & Operation

11.6.1 Initial pressure test (vby vacuum and Nitrogen) Step-by-step

1. Use a 4-port gauge manifold with 3/8" hose and connections to the vacuum pump. The vacuum gauge does not have to be connected for this part of the process.
2. Connect the gauges to service ports provided on receiver valve and suction tube. In order to remove any non-condensable that may have entered the system during installation, follow these steps:
3. Start the vacuum pump. The evaporator fan should be running and the compressor crankcase heater is energized at this point. This will involve powering up the unit so it is important to disconnect the live feed wire to the compressor contactor (so the compressor cannot run and the crankcase heater can be energized).
4. Open both valves on the manifold and then open the main vacuum valve on the pump. Run the system until the vacuum level of -0.85 bar (as read on manifold gauge) is achieved.
5. Shut off the main vacuum pump valve. Check for vacuum rise using the manifold compound gauge. A rise would indicate a large leak.
6. If vacuum holds for 10 minutes, break vacuum with nitrogen and pressurize to 20 bar. Check for leaks and repair leakage.

11.6.2 Leak Check

The success of all the subsequent commissioning depends on a leak free system, free of contaminants, free of oxides, free of non-condensables, that has been evacuated to a low vacuum and charged with the prescribed refrigerant.

Leak test is particularly important for field-connected systems. Typically, field systems lose as much as 20%–30% of their refrigeration charge annually. This is not only an unnecessary expense but also damages the environment. Compressor oil can be lost at the same time as refrigerant and eventually lead to compressor failure. (Time spent on leak test will eventually reduce the time spent on the evacuation process).

Ensure that all service valves are open during the leak test process. It is important to recheck all joints within the unit as well as the external joints.

1. The unit is shipped with a holding charge of dry nitrogen and should be leak free.
2. Ensure that the test pressure do not exceed the system design pressures.
3. Do not expose system pressure control LP to test pressures below the design pressure. This can damage the pressure controls.
4. Using an approved, calibrated electronic gas leak detector, leak test the entire system paying attention to all joints.
5. Periodically check functionality of the electronic leak detector during this process.
6. To further check system integrity, spray a soapy water solution over joins then visually inspect for bubbles.
7. Leave the system under pressure for a designated period (24 Hours).

8. Check and record the ambient temperatures and the system pressure with calibrated approved instruments. This process is to be carried out every 8-12 hours during the pressure testing process.
9. If the test pressures cannot be maintained, repeat the leak testing process employing the isolation of sections of the system to determine the source of leaks. Repair the leak and repeat the leak testing process until system can be signed off as leak free and approved by authorized personnel.
10. Record findings and confirm pressure testing process completion.

11.6.3 Evacuation

1. After the system is leak checked, connect approved dual stage vacuum pump sized to application with fresh oil to evacuation valve.
2. Ensure all inline system shut-off valves and solenoid valves are fully open.
3. Evacuate the system to 300 microns.
4. In case of non-availability of micron gauge, a triple evacuation is recommended.
5. The scroll compressor design requires system charging with liquid refrigerant into the liquid line.
6. Do not vapor charge the Large ZX Scroll unit. After ensuring all valves are opened and system is vacuumed properly, only then start the refrigerant charging process.

11.6.4 Charging and Commissioning

1. Ensure that there is no power supply to the Large ZX unit. The Liquid Line solenoid needs to be kept open for the charging process and this may require a temporary power feed to it.
2. Connect the refrigerant cylinder to main service hose and purge line at the manifold end.
3. Ensure correct orientation of the refrigerant cylinder. Follow cylinder labeling/instructions so that liquid refrigerant can be charged into the system. This will be charged through the high-pressure side of the manifold and Large ZX unit liquid service valve. Charge at least 70% of the required refrigerant in the system before starting the comp. Please do not bypass LP cutout during initial operation.
4. The compressor can then be started, and the unit continued to be charged (with controlled liquid refrigerant through the suction service valve). The quantity of charge should always be measured. See note.
5. The system needs to be operated down to its design evaporating temperature before you can be sure the charge is correct. It is at this point that the normal refrigeration operational checks can be carried out - such as checking the liquid line sight glass for violent bubbles and the operating pressures. Continue to charge about 1 kg after all the bubbles are gone in the liquid line sight glass. During this charging process the controller might show alarms E47 (EXV fully open) and E48 (injection shortage) which is to be ignored as unit is not completely charged. Refrigerant charging is regarded full/complete when the operating temperature of the system has been stable for some time and the liquid line sight glass is clear.

11.6.5 Additional Oil Charing in the System

Additional Oil Charing in the System - Emerson Large ZX units are supplied with oil charge in the compressor as well as the oil separator / reservoir. However, depends on the length of interconnecting piping and the refrigerant charge in the system, there might be additional oil requirement. If the oil level in the oil reservoir goes below the lower sight glass after the system running for some time, customer needs to charge additional oil charge through suction line using manual oil pump and raise the oil level at least up to mid-level of the lower sight glass.

Refrigerant	Oil
R404A, R507, R448A, R449A, R407F	Emkarate RL 32 3MAF Mobil EAL Arctic 22 CC

11.6.6 Checks before starting and during running the system

1. Check all the valved are fully opened
2. Check the oil level of compressor and the reservoir after running the unit for some time.
3. Check the discharge line temperature which is to be below 125 °C.
4. Suction and discharge pressures are within the operating envelope.
5. The operating current is corresponding to the suction and discharge pressures.
6. The compressor bottom shell is within the safe range as shown below

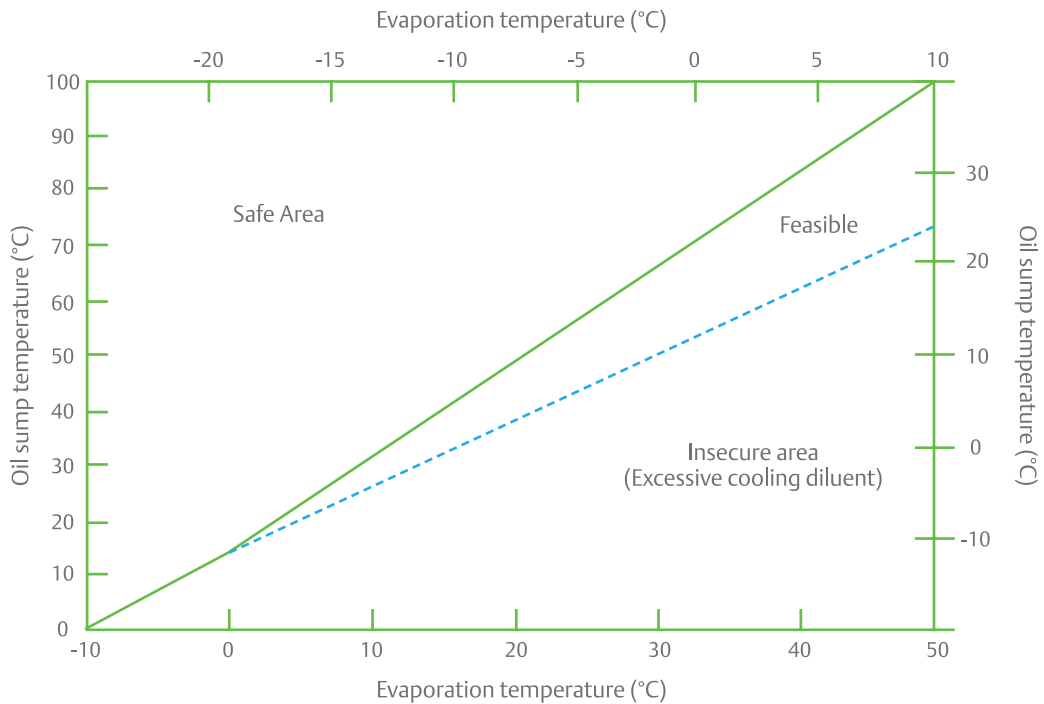

11.6.6.7. Maintenance

Condenser Fins

Condenser fins become dirty over time as ambient air is induced to the condenser. Dirty coil surfaces result in high condensing temperatures and poor unit performance. Regular cleaning is recommended with frequency depending on the installation and the surrounding environment. As a general guide, it is advisable to do this at least once every two months.

Fins should be cleaned with liquid detergent diluted with clean water. Before washing, a light brush downward (in the direction of the fins) should be done to remove heavy deposits.

Routine Leak Test

All joints should be checked for leaks during site visits. All joints should be leak tested once a year. Condenser Fan(s) and Motor(s), an annual inspection of these items is recommended. Fastenings may loosen, bearings may wear, and fans may require cleaning of solid deposits which can cause imbalance



TURN OFF OR DISCONNECT THE ELECTRICAL POWER SOURCE BEFORE CLEANING THE CONDENSER COIL OR DOING MAINTENANCE.

12. Troubleshooting

Alarm Codes

Level	Descriptions
Warning	The unit (including the compressor) will keep running, but some status & data is already in an unsafe range; alarm dry-contact will not close; reset automatically
Alarm	The unit (including the compressor) may run not with full functions; alarm dry-contact will not close; reset automatically
Lock	The unit (including the compressor) stops working; alarm dry-contact will close; manual reset is needed

Code	Description	Possible Reasons	Action	Reset
E01	Suction pressure sensor failure alarm	Sensor failure or overrange	Digital compressor operates in preset mode	Reset automatically when the sensor is working
E02	Condensing pressure sensor failure alarm	Sensor failure or overrange	Function: fan speed control is disabled	Reset automatically when the sensor is working
E03	Digital compressor discharge line temperature sensor failure alarm	Sensor failure or overrange	Function: discharge temperature protection is disabled	Reset automatically when the sensor is working
E04	PHE vapor inlet temperature probe failure alarm	Sensor failure or overrange	Function: PHE superheat control is disabled	Reset automatically when the sensor is working
E05	PHE vapor outlet temperature probe failure alarm	Sensor failure or overrange	Function: PHE superheat control is disabled	Reset automatically when the sensor is working
E06	Ambient temperature probe failure alarm	Sensor failure or overrange	Related functional disabled	Reset automatically when the sensor is working
E07	Fixed-speed compressor discharge line temperature sensor failure alarm	Sensor failure or overrange	Fixed-speed compressor discharge line temperature protection function disabled	Reset automatically when the sensor is working
E09	#1 current sensor fault alarm	Current overrange	Current protection function disabled	Reset automatically when the sensor is working
E10	#2 current sensor fault alarm	Current overrange	Current protection function disabled	Reset automatically when the sensor is working
E11	#1 voltage sensor fault alarm	Voltage overrange	Voltage protection disabled	Reset automatically when the sensor is working
E12	#1 voltage sensor fault alarm	Voltage overrange	Voltage protection disabled	Reset automatically when the sensor is working
E13	#3 voltage sensor fault alarm	Voltage overrange	Voltage protection disabled	Reset automatically when the sensor is working
E20	Missing phase alarm	One or two phases of the compressor power supply are missing or the voltage sensor is working abnormally	The compressor will be tripped	Automatically with time delay
L20	Missing phase lock	Missing phase alarm happened frequently	The compressor will be tripped and the unit will be locked	Press 'Start' > 5 seconds or manually power cycle
L21	Wrong phase sequence lock	Compressor power supply has wrong sequence	The compressor will be tripped and the unit will be locked	Press 'Start' > 5 seconds or manually power cycle

Code	Description	Possible Reasons	Action	Reset
E22	Three-phase imbalance warning	3-Ph voltages are not balanced	no	no
E23	Digital compressor over current alarm	Digital compressor current is larger than settings	The compressor will be tripped	Automatically with time delay
L23	Digital compressor over current lock	Digital compressor over current alarm happens frequently	The compressor will be tripped and the unit will be locked	Press "Start" > 5 seconds or manually power cycle
E26	Low voltage alarm	Voltage is lower than settings; or voltage sensors do not work	The compressor will be tripped	Automatically with time delay
L26	Low voltage lock	Low voltage alarm happens frequently	The compressor will be tripped and the unit will be locked	Press "Start" > 5 seconds or manually power cycle
E27	Over voltage alarm	Voltage is higher than settings	The compressor will be tripped	Automatically with time delay
L27	Over voltage lock	Over voltage alarm happens frequently	The compressor will be tripped and the unit will be locked	Press "Start" > 5 seconds or manually power cycle
E28	Digital compressor built-in protector opens alarm	Digital compressor built-in protector opens	The digital compressor will be tripped	Automatically with time delay
E31	Fix speed compressor over current alarm	Fix speed compressor current is larger than settings	The compressor will be tripped	Automatically with time delay
L31	Fixed speed compressor over current lock	Fix compressor over current alarm happens frequently	The compressor will be tripped and the unit will be locked	Press "Start" > 5 seconds or manually power cycle
E32	Fix speed compressor built-in protector opens alarm	Fixed speed compressor built-in protector opens	The digital compressor will be tripped	Automatically with time delay
E40	High pressure switch alarm	High pressure switch is open	The digital compressor will be tripped	Automatically when HP switch closes
L40	High pressure switch lock	High pressure switch alarm happens frequently	The compressor will be tripped and the unit will be locked	Press "Start" > 5 seconds or manually power cycle
E41	Low pressure switch alarm	Low pressure switch is open	The digital compressor will be tripped	Automatically when LP switch closes and time delay
E44	Digital compressor discharge line temperature overheating alarm	Digital compressor Discharge temperature is higher than settings	The digital compressor will be tripped	Automatically when discharge temperature is lower than settings and time delay
L44	Digital compressor discharge temperature overheating lock	Digital compressors high discharge temperature alarm happens frequently	The compressor will be tripped and the unit will be locked	Press "Start" > 5 seconds or manually power cycle
E45	High condensing pressure warning	Condensing pressure is higher than settings	no	Automatically when condensing pressure is lower than settings
E46	High condensing temperature warning	Condensing temperature is higher than settings	no	Automatically when condensing temperature is lower than settings
E47	EXV full-open warning	Less refrigerant charge or leakage	no	Automatically reset when the EXV is not fully open
E48	Less injection warning	Less refrigerant charge or leakage	no	Automatically when PHE super heat is smaller than settings

Code	Description	Possible Reasons	Action	Reset
E50	Liquid flood back warning	Low evaporator super heat or too much liquid injection to the compressor	no	Automatically when the difference of discharge temperature and condensing temperature is higher than setting and time delay
E55	Fix speed compressor discharge line temperature overheating alarm	Fix speed compressor Discharge temperature is higher than settings	The compressor will be tripped	Automatically when discharge temperature is lower than settings and time delay
L55	Fix speed compressor discharge temperature overheating lock	Fix speed compressors high discharge temperature alarm happens frequently	The compressor will be tripped and the unit will be locked	Press "Start" > 5 seconds or manually power cycle
E56	Compressor oil shortage alarm	Compressor lack of oil	The compressor will be tripped	Automatically with time delay
L56	Compressor oil shortage lock	Compressor lack of oil alarm happens frequently	The compressor will be tripped and the unit will be locked	Press "Start" > 5 seconds or manually power cycle
E80	RTC warning	The time configured for the new controller	no	Automatically when finish time configuration
E81	RTF warning	Communication error between MCU and unit clock	no	Automatically when the communication recovers
E82	Probe configuration error alarm	The same probes are configured	no	Automatically when the probes are configured correctly
E83	Digital inputs configuration error alarm	The same digital inputs are configured	Related function failure	Automatically when the digital inputs are configured correctly
E84	Compressor configuration error alarm	Digital compressor and solenoid valve configuration does not match	The compressor will not work	Manually power off and power on after the compressor configuration is right
E85	Injection probe configuration error alarm	EXV and injection configuration does not match	EXV will not work	Automatically when the injection probe is configured correctly
L86	EEPROM read/write error lock	Write/read error into EEPROM	The compressor will be tripped and the unit will be locked	Hold "Start" button for 5s or manual power off and on, alarm will disappear when the communication between the MCU and the EEPROM is successful.



Fault phenomenon	Direct cause	Inspection analysis and adjustment	
Before the following troubleshooting, first of all ensure the correctness, robustness and reliability of all wiring			
<p>1 Compressor does not start</p> 	The controller did not receive a start signal	<p>Check whether the low pressure reaches the low pressure set point</p> <p>Check terminal No. 3 and NEUTRAL neutral line for 220VAC</p> <p>Check whether the wiring of terminal block No. 3 to controller input DI1 is reliable</p> <p>Normal shutdown will not start within 3 minutes, waiting time exceeds 3 minutes</p>	
	Contactor failure or wiring failure	Check whether the contactor coil A1 has 220V AC. If there is 220VAC, check the virtual connection of the compressor terminal and the contactor coil terminal or replace the contactor; if no 220VAC, check if the controller C2 FireWire is connected properly	
	Controller failure	Replace the controller	
	Electricity failure	Need to confirm that the power supply voltage and waveform are normal	
	The fuse is blown	Replace the fuse and monitor the current after restart	
	Air switch trip	Need to confirm whether over current, whether leakage grounding is normal, whether the air switch itself is faulty	
	Contactor failure	Need to confirm whether the contact is stuck, whether the starting voltage is insufficient	
	Unit control is in protection status (alarm code display)	Check whether it is a true protection action or a malfunction due to a fault code	
	Power supply phase error (L21)	Refer to Article 14 [Phase of three phases] Related Content	
	Power Phase Loss (E20 or L20)	Refer to Article 13 [Three-phase phase loss] Related content	
Three-phase voltage imbalance	Need to confirm whether there is a virtual connection of the power line, whether it is used in a phase of high-power single-phase electrical appliances		
<p>Not bright / flashing, Compressor does not start</p> 	Compressor Overcurrent (E23/L23: Digital Compressor, E31/L31: Constant Speed Compressor)	Refer to Article 15 [Overcurrent Errors] Related Content	
	Exhaust pressure too high protection (E40 or L40)	Refer to Article 2 [Exhaust Pressure High Protection] Related Content	
	Inspiratory pressure too low protection (E41)	Refer to Sections 3,4 [Insufflation Pressure Protection] Related Content	
	Excessive exhaust temperature protection (E44/L44: digital compressor, E55/L55: fixed speed compressor)	Refer to Article 5 [Exhaust temperature protection is too high] Related content	
	User-side temperature controller instruction shutdown	Need to confirm whether it has reached the temperature set point, whether it enters the defrost program, whether the thermostat is faulty	
	Controller failure or transformer failure	Need to confirm whether the controller display is on. Replace the controller to see if the fault still exists.	
	Built-in compressor protection (E28: digital compressor, E32: fixed speed compressor)	Refer to Article 15 [Controller Output Run Command but No Compressor Current Detected]	
	Power supply voltage is too low	A) Check whether the power supply voltage deviation meets the unit usage requirements	
	Capacitor failure		A) Confirm that the capacitor wiring and specifications are correct (refer to the unit wiring diagram)
			B) Check if the capacitor is damaged

Fault phenomenon	Direct cause	Inspection analysis and adjustment
<p>2</p> <p>Code “E40 or L40”</p> <p>Discharge pressure</p> <p>High protection</p> <p>or lock</p>	If the high pressure is high (high pressure protection value 30 kg):	
	Shutoff valve or other system valve forgot to open	One-by-one confirmation of system processes
	The ambient temperature is too high or the air intake channel is blocked	Improve ventilation and ensure that the return air temperature of the condenser is equal to the ambient temperature outside the building, ensure sufficient airflow space before and after the unit.
	Condensing fan is working abnormally	Reference No. 12 [Condensing fan does not operate, or operates abnormally]
	Dirty condenser surface	Sweep condenser
	Too much refrigerant	For non-azeotropic refrigerants, such as R404A, release some of the refrigerant from the stop valve of the liquid tube, and use slow release to prevent excessive loss of the lubricant
	Air inside the system	There may be intermittent air bubbles in the sight glass. If it is confirmed that air is in the system, need to remove air (re-vacuum and add refrigerant)
	Over-throttle	A) Check throttling device is normally open B) Choosing throttling device is too small
	High pressure switch failure	Short-circuit the two ends of the controller directly to connect the high pressure switch, and confirm whether the high pressure switch is damaged
	FireWire to C2 port is open all the way	If the “E40 or L40” is reported at the same time the fan is not working, please check: 1. If the two fuses next to the contactor are damaged; 2. Check the terminal block and the controller under the line wiring for loose or wrong connection
Controller failure	Controller shows error, replace controller	
<p>3</p> <p>Code “E41”</p> <p>suction pressure</p> <p>Low protection</p> <p>(limited to medium temperature unit)</p>	Wrong controller	The controller for medium temperature unit ZXD and the low temperature unit ZXLD must be used in one-to-one correspondence.
	Low pressure switch and wiring fault	Ensure that the low pressure switch should be closed (turned on) when the low pressure is greater than 1 kg
<p>4</p> <p>Suction pressure is too low</p>	Shutoff valves in the system does not open properly	Check the system valves one by one
	System lack of refrigerant	Need to confirm whether the charge is insufficient whether the system leaks. If the system leaks, need to find leak point and handle properly
	Abnormal evaporator, heat exchanger is too small	Need to confirm whether the evaporator fan and the motor are abnormal, whether it is defrosting, defrosting is not clean, whether the drainage is not smooth, and whether the sundries obstruct the airflow passage.
	Expansion valve opening is too small	Whether the expansion valve is blocked or if the expansion valve is improperly adjusted. Whether temperature package leaks
	Filter plugging, suction pipe pressure drop too high	Need to confirm whether filter is dirty, if it is blocked by ice, if it needs to be replaced, replace the filter or replace the filter core
	Part selection deviation	Evaporator selection is too small, or the expansion valve selection is too small, or the unit selection is too large. Recheck the load and select the model. Whether medium temperature units are used for low temperature applications

Fault phenomenon	Direct cause	Inspection analysis and adjustment
<p>5</p> <p>Code "E44/L44" Digital compressor discharge gas overheating alarm or locked</p> <p>Code "E55/L55" Fixed speed compressor discharge gas overheating alarm or locked</p>	Low pressure during normal operation	Measure operating low pressure. Need to confirm whether the low pressure set in controller is correctly, whether the controller or low pressure switch is faulty. If there is a fault, replace the corresponding device. Also refer to [3. suction pressure Low protection] Related Content.
	Shutoff valve or other system valve forgot to open	To measure the operating high pressure, make sure that the high pressure switch is working properly. If there is a fault, replace the corresponding device. Also refer to [2. Discharge pressure High protection Or lock].
	The ambient temperature is too high or the air intake channel is blocked	Need to confirm whether there is a lack of refrigerant, whether the opening of the expansion valve is too small, whether insufficient insulation of the suction pipe.
	Injection system failure	<p>A) The need to confirm whether the electronic expansion valve failure: coil damage, dirty or ice blocking.</p> <p>B) The need to confirm whether the electronic expansion valve is blocked.</p> <p>C) It is necessary to confirm whether the inlet/temperature sensor for PHE is faulty or missing. Refer to the sensor temperature-resistance characteristics table in this manual.</p> <p>D) It is necessary to confirm whether insufficient charging leads to gas-liquid two-phase in the liquid pipe, so that the injection circuit cannot take liquid properly.</p> <p>E) Need to confirm if the controller is faulty.</p>
	Refrigerant mixed with impurities, refrigerant composition changes	Re-evaevacuation and charge of qualified refrigerant.
	System lacks of refrigerant	<p>1, the sight glass should be full glass status.</p> <p>2, the liquid pipe should have sufficient subcooling. Need to confirm whether the charges is insufficient, whether the system leaks. If leaks need to find leak point and handle properly.</p>
	Compressor failure	It is necessary to confirm whether the compressor current corresponds to operating high and low pressure. If not, the compressor may have worn.
	Discharge temperature sensor and wiring fault (measured discharge temperature is less than 125 degrees)	Check if the sensor fails and check if the sensor falls out. Refer to the sensor temperature-resistance characteristics table in this manual.
<p>6</p> <p>The system continues to have liquid, back Suction superheat less than 5K (such as frost o compressor body in medium tepearature unit)</p>	Wrong controller	Need to confirm whether the expansion valve is oversized and whether it is excessive opening
	Abnormal evaporator, heat exchanger is too small	Need to confirm whether the evaporator fan and the motor are abnormal, whether it is defrosting, defrosting is not clean, whether the drainage is not smooth, and whether the sundries obstruct the airflow passage.
	Too much refrigerant	For non-azeotropic refrigerants, such as R404A, release some of the refrigerant from the stop valve of the liquid tube, and release slowly to prevent excessive loss of the lubricant.

Fault phenomenon	Direct cause	Inspection analysis and adjustment
7 Frequent compressors start up	If the compressor starts frequently during the defrosting process:	
	Operating suction pressure low due to low load	Need to confirm whether the unit selection is too large, the expansion valve selection is too small. Consider taking all indoor evaporator synchronization defrosting procedures
	Leakage of liquid line solenoid valve	Check if the low pressure rises during stop, replace the corresponding equipment (coil or valve body) when confirming the failure of the solenoid valve
	Too much pressure drop in suction piping	Measure the pressure change at compressor suction and evaporator outlet during the shutdown process. It may be that the compressor suction pressure has decreased to the stop setting and the evaporator side liquid refrigerant has not completely evaporated. Need to improve piping design
	If the compressor is frequently started during normal operation:	
	The unit is at initial startup	It is normal phenomenon. At first time start after power on or over 1 hour shut o, the unit is in initial start procedure, during which the compressor will strat up 3 times with 3 seconds running in each time, each time with 20 seconds interval.
	Frequent compressor protection (alarm code display)	Refer to [Compressor overcurrent], [Discharge pressure high pressure], [Suction pressure too low protection], [Discharge gas overheating] related content for detailed system check
	Thermostat failure	Check if the temperature dierence between the start and stop of the thermostat is too small, and whether the thermostat fault frequently issues a stop command. If there is a fault, replace the corresponding device
	Controller failure	Try to replace the controller and see if the fault persists
Low pressure during normal operation	Measure operating low pressure. Need to confirm whether the low pressure set is correctly, whether the low pressure switch is faulty? If there is a fault, replace the corresponding device. Also refer to the relevant content of Article 3 [suction pressure Low protection	

Fault phenomenon	Direct cause	Inspection analysis and adjustment
8 Abnormal noise	Compressor reverse running	Swap any two-phase wiring
	The compressor is overloaded	Check if the high-pressure pressure is running high, whether the low-pressure pressure is low, and whether the pressure ratio is too large.
	The compressor oil level is too low or too high	Confirm the oil level and perform oil drain or replenishment
	Too much refrigerant	Release some of the refrigerant from the stop valve liquid line slowly to prevent excessive loss of lubricating oil
	Continuous liquid back	Check if compressor oil tank temperature is low
	System with liquid start	Check whether the compressor crankcase heater is working during compressor stops and whether the liquid solenoid valve leaks.
	Compressor internal failure	Check if the compressor current corresponds to operating high and low pressure. If it is too high, it may indicate that the inside of the compressor may have worn
	Unit resonance	Try to press each pipe, bracket, housing, condenser, etc., and observe if the noise changes. After confirming the source of noise, reinforce, separate, or add sponge cushions to the corresponding parts.
	Unit contacts surrounding objects	Ensure that the space around the unit is clean and open, and that the unit body does not touch other objects (such as wires, sundries, etc.)
	Unit installation is loose	Reconfirm that the feet of the unit are firmly installed, no nuts in loose and no feet are impending
Low condensing pressure	Low Ambient Kit (BOM-*81) should be selected in extremely low ambient areas, check if the fan speed control is normal	
9 Cooling capacity cannot meet load demand	The unit is operating normally	Check if the unit operating is normal by checking if high pressure, low pressure, current, discharge temperature, return gas temperature, oil temperature are within a normal range. If yes, it is possible that the outdoor or indoor equipemnt selection is too small, and the system needs to be redesigned.
	Unit protection	Refer to above related content for detailed system check
	The compressor itself is working abnormally	Refer to section 1 [Compressor does not start] for detailed system check]
	Flash gas before system expansion valve	The liquid line should be full of liquid before expansion valve (sight glass should be installed before the expansion valve)
	Liquid supply pipe insulation for units with PHE	The liquid supply pipe should be well insulated for units with PHE
	System lack of refrigerant	1, the sight glass should be full glass liquid 2, (for units with PHE) The liquid pipe should have sufficient subcooling, check whether the charge is insufficient and whether the system is leaking. If the system leaks, need to find the leaking' point and fix it.
Abnormal application status	Check the working status of the evaporator, check if the cooler's door is closed, check the goods temperature when putting into the cooler	

Fault phenomenon	Direct cause	Inspection analysis and adjustment
<p>10 Controller has no display</p>	Circuit breaker cannot be turned on after closing	When the breaker is closed, the breaker has 380V input voltage and output voltage
	Natural wiring error	Any line-to-neutral voltage is 220VAC
	Broken fuse	Whether the two fuses next to the contactor are damaged
	Transformer damage	Measure whether the transformer input has 220V voltage and whether the output has 24V voltage. If the output is abnormal, replace the transformer.
<p>11 Controller does not work</p>	Controller code does not change or garbled	Power o and power on the unit, after re-start the controller, if the fault disappears, the fault can be ignored
	Controller failure	If the fault continues, replace the controller
<p>12 The condenser fan is not running, or in abnormal operation</p>	Check if the fan blade is damaged	Check if the fan blade is damaged
	Check if fan motor malfunctions	Fan should be connected to fan capacitor and wired to 220VAC; check if fan motor failure or fan capacitor failure
	Check if the fan capacitor is damaged	Fan should be connected to fan capacitor and wired to 220VAC; check if fan motor failure or fan capacitor failure
	If above causes are excluded, replace the controller	Note: The condensing fan speed control is based on the condensing temperature collected, when condensing temperature sensor failures, will use ambient temperature sensor for speed control, if both sensors fail, the fan will be fully open. Refer to the sensor temperature-resistance characteristics table in this manual
<p>13 Code “E20” or “L20” three-phase phase missing</p>	Controller H25 parameter setting error	Check the label of the unit and check whether the parameters of the controller H25 are set correctly. The three-phase power is set to Yes and the single-phase is No. Please pay special attention to this after replacing the controller
<p>14 Code “L21” three-phase phase Fault</p>	The phase sequence of the unit incoming 3-ph lines is incorrect	Check the three-phase incoming line of the unit and exchange the two phases of the breaker input line
	Controller three-phase error	Check whether the three-phase input of R, S, T in the lower left corner of the controller is consistent with the phase sequence on the terminal of the compressor (U, V, W). Take special attention when replacing a new controller.

Fault phenomenon	Direct cause	Inspection analysis and adjustment
<p>15 Code "E28" controller outputs digital compressor operation instructions, No current detected</p> <p>Code "E32" controller outputs operation command, No current detected</p>	Built-in compressor protection	Measure the resistance between the terminals of the compressor to determine if the resistance is infinite and whether the three-phase resistance is balanced. After the compressor is fully cooled, try to start again. If normal operation can be performed again, please refer to [Compressor overcurrent], [Discharge pressure high protection], [Suction pressure low protection] and [Discharge gas overheating] to perform detailed system checks.
	Compressor motor burned	Measure the resistance between the terminals of the compressor. If it is confirmed that the compressor is faulty, replace the compressor. After restarting, you must refer to [Compressor overcurrent], [Discharge pressure high protection], [suction pressure low protection], [Discharge gas overheating] to perform detailed system checks.
	Compressor mechanical failure	Need to confirm whether the current is too high. whether the noise is high, with or without abnormal noise. If it is confirmed that the compressor is faulty, replace the compressor. After restarting, you must refer to [Compressor overcurrent], [Discharge pressure high protection], [suction pressure low protection], [Discharge gas overheating] to perform detailed system checks.
	Contactor and wiring fault	Check the three-phase voltage at the lower end of the contactor to determine whether there is loose or virtual connection, and replace the contactor
	Controller failure	Replace the controller.
<p>16 Code "E23/L23" Digital Compressor Over current alarm or lock</p> <p>Code "E31/L31" Fix Speed Compressor Over current alarm or lock</p>	Controller current protection setting wrong	Check whether the controller H07/H09 (digital compressor) and H27/28 (fix speed compressor) parameter values are consistent with the unit label. Especially when replacing a new controller, adjust the controller parameters to match the unit's labeling requirements.
	Contactor failure	Check the three-phase voltage at the lower end of the contactor to determine whether there is loose or virtual, resulting in excessive current due to missing phase.
	Internal damage to the compressor	Measure the actual operating current of the compressor, and determine whether the operating current is too high by referring to the high and low pressures.
<p>17 Code "E03"(digital compressor), "E07" (fix speed compressor) discharge line temperature sensor error</p>	Discharge line temperature sensor falls out or is not heat insulated well	Check if the temperature sensor is out or the heat insulation is not good
	The sensor itself fails	It is recommended to replace the temperature sensor directly
<p>18 Code "E01" Suction pressure transducer failure</p>	Actual suction pressure exceeds the transducer measuring range	Find out why the pressure is abnormal, like if there is no refrigerant in the system, or if the refrigerant is too much, so the pressure in the suction is too high.
	Pressure is normal, sensor connection or sensor itself fails	Check if the sensor wiring is normal and there is no blockage in the pressure tube where the sensor is located. Try replacing the sensor to see if it can eliminate the fault.

Fault phenomenon	Direct cause	Inspection analysis and adjustment
19 Code "L86" Controller internal memory EEPROM is abnormal	Controller internal memory is abnormal	Check whether the external device has remote communication with the controller, and whether there is any abnormality in the remote communication wiring and signal transmission. If the signal continues to be written into the controller, it will cause its memory to be damaged, and each writing requires a write completion instruction. Try to restart the controller if it can be solved. After the above troubleshooting, if the controller is still abnormal, replace the controller.

Temperature Sensor Resistance Table

Temperature (°C)	-30	-10	25	60	80	100	120
Discharge line temperature sensor resistance (Ω)	1522k	457k	86k	21k	11k	5.8k	3.4k
Condensing temperature, PHE vapor inlet and outlet temperature and ambient temperature sensor resistance (Ω)	111k	67.7k	42.5k	27.3k	17.9k	10k	5.82k

About Emerson

Emerson (NYSE: EMR), headquartered in St. Louis, Missouri (USA), is a global technology and engineering company providing innovative solutions for customers in industrial, commercial, and residential markets. Our Emerson Automation Solutions business helps process, hybrid, and discrete manufacturers maximize production, protect personnel and the environment while optimizing their energy and operating costs. Our Emerson Commercial and Residential Solutions business helps ensure human comfort and health, protect food quality and safety, advance energy efficiency, and create sustainable infrastructure. For more information visit Emerson.com.

Contact lists

United Arab Emirates

Jebel Ali Free Zone
P.O. Box 26382, Dubai
United Arab Emirates
Toll Free: 8000 441 3428
Tel: +971 4 8118100
Fax: +971 4 8865465

Saudi Arabia

P.O. Box 3620 - 34332
2nd Industrial City, 67 St.
Dammam, Saudi Arabia
Toll Free: 8008 443 426
Tel: +966 3 8147560
Fax: +966 3 8147570

South Africa

11 Quark Crescent
Linbro Business Park
Sandton 2065, South Africa
Toll Free: 0800 980 371
Tel: +27 11 451 3700
Fax: +27 11 451 3800

Egypt

P.O.Box 11799
11 Mustafa Refaat Street
Sheraton, Heliopolis
Cairo, Egypt
Tel: +20 2 226 5854



EmersonClimateMEA.com

COPELAND™