

MOTORS FOR COPELAND SCROLL™ COMPRESSORS

1 Built in Motors for Scroll Refrigerant Compressors

The electric motors integrated in the compressor shell have been designed especially for use in refrigerant compressors. As they are subject to various loads in the application area of the compressor and come into contact with refrigerant and refrigerant machine oil, high grade and highly resistant insulation materials have been used.

The motor insulation material for scroll compressors models is shown in the table below.

Air conditioning	Refrigeration	Heat pump	Class
ZR18K4E to ZR81KCE	ZF06K4E to ZF18K4E	ZH15K4E to ZH45K4E	B
ZR94KCE to ZR190KCE	ZF13KVE, ZF18KV4E	ZH09KVE to ZH18KVE	
ZP23KCE to ZP182KCE	ZB15K4E to ZB45K4E		
ZBH30KJE to ZBH45KJE	ZS15K4E to ZS45K4E		
ZBHV45KJE	ZO34K3E to ZO104K3E		
ZRH49KJE to ZRH72KJE	ZBD30KCE, ZBD45KCE		
ZRHV72KJE	ZFD18KVE		
ZRD42KCE to ZRD125KCE			
ZPD61KCE to ZPD81KCE			
ZR90K3E to ZR380KCE	ZF24K4E to ZF48K4E	ZH56K4E to ZH11M4E	
ZP235KCE to ZP385KCE	ZF24KVE to ZF48KVE	ZH24KVE to ZH48KVE	
	ZB56K4E to ZB220KCE		
	ZS56K4E to ZS11M4E		

All model ranges relate to VDE 0530 / DIN 57530 / IEC 34-18-1 / EN 0530.

All motors are adapted to each specific optimum application area so that the compressor is highly effective when using full or part load.

2 Motor Code

Scroll refrigerant compressors are available in various motor versions depending upon the size of the load. The motor versions differ in operating voltage, type of switching, number of phases, frequency and type of motor protection. A code for the motor is included in the model designation to ensure correct designation because of the many variations available during order handling and service. An example for the compressor model designation is given below.

ZR40K3E - P F J
 ZP235KCE - T W C
 ZS26KCE - T F D
 ZF48K4E - T W 7
 ZB11MCE - T W D
 ZH56K4E - T W R

Motor Type	Motor Protection Device	Motor Voltages				
		V	Ph	Hz		
P Single-phase motor	F Inherent Internal klixon line break motor protection	J	220/240	1	50	
			265	1	60	
T Three-phase motor		W For three-phase motors, electronic motor protection with thermistors terminal box	C	200	3	50
				208/230	3	60
D			380/420	3	50	
			460	3	60	
E			575	3	60	
R			220/240	3	50	
5			200/220	3	50	
			200/230	3	60	
7	380		3	60		
M	380/420		3	50		

Table 1: Key to Motor Code

Note: If there is the letter N at the end of the motor code (for example TFDN) the motor is not UL approved but is suitable for use within the EU

3 Motor Voltages and Frequencies

3.1 Nominal voltage range

A nominal voltage range pertaining to the motor is stated in Select Software and on compressor nameplates as opposed to one single nominal voltage. Copeland Scroll compressors have a voltage tolerance of + 10%.

Example: Compressor model ZR19M3E - TWD

Nominal voltage range according to the nameplate 380-420V / 3 / 50 – 460V / 3 / 60

Voltage tolerance of + 10%

Voltage range

- a) From 380V - 10% = 342V to 420V + 10% = 462V at 50 Hz
- b) At 460V - 10% = 414V to 460V + 10% = 506V at 60 Hz

The compressor can be put into full operation within the specified load limits throughout this voltage range.

3.2 Frequency

Copeland Scroll compressors are available for 50 Hz and / or 60 Hz voltage supply. The use of a 50 Hz single or three-phase motor with 60 Hz and vice-versa is possible. In this instance the following calculation factors need to be considered.

	50Hz → 60 Hz	60 Hz → 50 Hz
Refrigeration Capacity	1.2	0.83
Power Input	1.2	0.83
Speed	1.2	0.83

Code	Power Supply	Nominal Voltage	Connection	Amps Factor
TFD	380/420-3-50	400	Y	1
TF5	200/220-3-50	200	Y	2
TWC	200-3-50	200	Y	2
TWD	380/420-3-50	400	Y	1
TWR	220/240-3-50	220	Y	1.8
TWM	380/420-3-50	400	Y	1

Code	Power Supply	Nominal Voltage	Connection	Amps Factor
TFD	460-3-60	460	Y	1
TF5	200/230-3-60	230	Y	2
TWC	208/230-3-60	230	Y	2
TWD	460-3-60	460	Y	1
TWE	575/3/60	575	Y	0.8
TW7	380/3/60	380	Y	1.2
TFM	380/420-3-50	400	Y	1

Table 2: Calculation Factors

4 Brief Power Interruptions

With single-phase Scroll compressors built before May 1995 (serial no. 95E), brief power interruptions of less than 1/2 second may result in powered reverse rotation. This occurs as a result of the high-pressure discharge gas expanding backwards through the scrolls on power interruption, causing the scroll to orbit in the reverse direction. When power is reapplied while reverse rotation is occurring, the compressor may continue to run in the reverse direction for several minutes until the compressor’s internal protector trips. This has no effect on durability. When the protector resets the compressor will start and run normally.

To avoid the loss of cooling resulting from reverse rotation Copeland strongly encourages the use of an electronic control which can sense brief power interruptions and will lock the compressor out of operation for five minutes. This control could be incorporated with the other system controls (such as defrost or thermostat), or be a stand-alone control. Functional specifications for this control are the following:

Timer opens: 1 electrical cycle (0,02 sec at 50-Hz operation) after power is removed and closes: 5 minutes (± 20 %) delayed whether power is restored or not. No such device is required on three-phase models.

5 Starting

During the very brief start-up, a short metallic sound is audible, resulting from initial contacting of the spirals and is normal. No start assist devices are required for single-phase compressors, even if a system utilizes non-bleed expansion valves. Due to the design of the Copland Scroll, the internal compression components always start unloaded even if system pressures are not balanced. In addition, since internal compressor pressures are always balanced at start-up, low-voltage starting characteristics are excellent for Scroll compressors.

6 Electrical Installation

Single-Phase Fusite

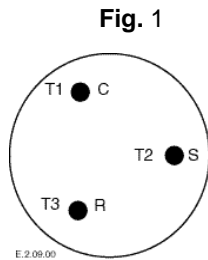

Three-Phase Fusite

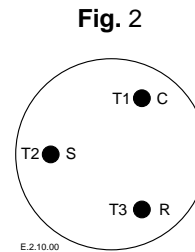

Single-phase compressors (Fig.1) are connected to the common (C), start (S) and run (R) connections.

Fusite connections are marked as in figure 1 (single-phase) and figure 2 (three-phase). Recommended wiring diagrams are shown in figures 4 and 5.

Fig. 3

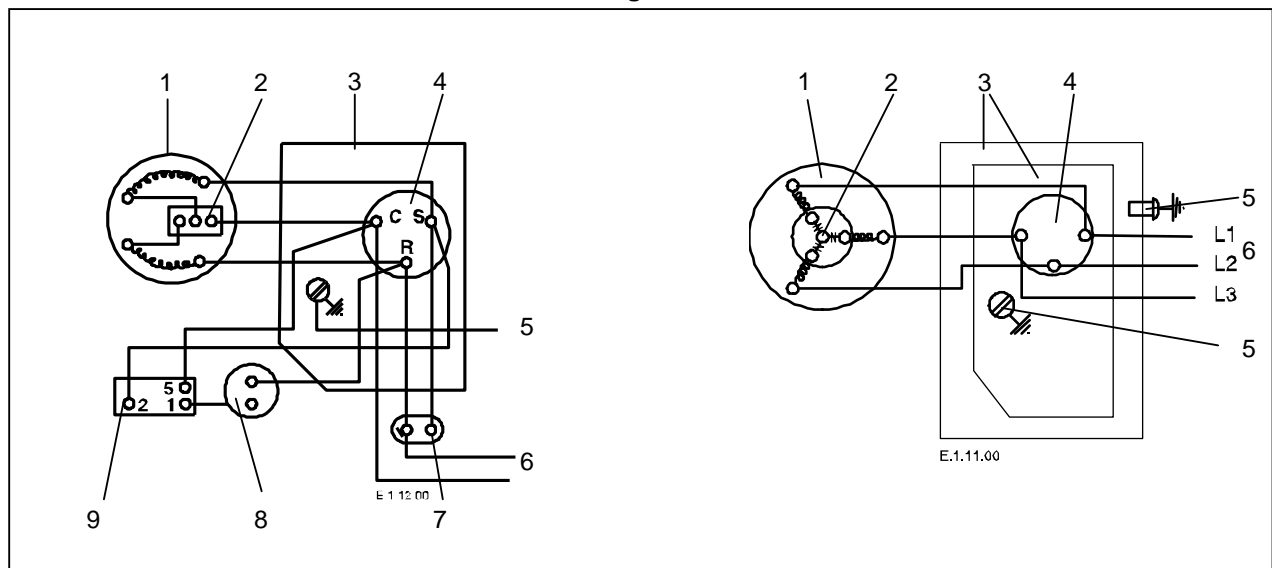

Legend (to Fig 3.)

- | | | | |
|---|------------------------------------|---|----------------------------|
| 1 | Motor | 6 | Power supply |
| 2 | Internal inherent motor protection | 7 | Run capacitor (optional) |
| 3 | Terminal box | 8 | Start capacitor (optional) |
| 4 | Lead connection | 9 | Relay (optional) |
| 5 | Earthing connection | | |

Independently from the internal motor protection, motor protection devices such as circuit breakers and fuses F6...8 have to be installed before the compressor as shown in figures 3 and 4. Selection of fuses has to be carried out according to VDE 0635 or DIN 57635 or IEC 269-1 or EN60-269-1.

Scroll compressors like several other types of compressors, will only compress in one rotational direction. Direction of rotation is not an issue with single-phase compressors since they will always start and run in the proper direction.

Three-phase compressors will rotate in either direction depending upon phasing of the power to L1, L2 and L3. Since there is a 50/50 chance of connecting power in such a way as to cause rotation in the reverse direction, it is important to include notices and instructions in appropriate locations on the equipment to ensure proper rotation direction is achieved when the system is installed and operated. The correct direction of rotation can be confirmed by observing that the discharge pressure rises and the suction pressure falls when the compressor is operated. Reverse rotation results in a sound level above that with correct rotation direction, as well as substantially reduced current draw compared to tabulated values and after several minutes of operation the compressor's internal protector will trip.

All three-phase compressors are wired identically internally. As a result, once the correct phasing is determined for a specific system or installation, connecting properly phased power leads to the same terminals should maintain proper rotation direction.

7 Power and Control Circuits

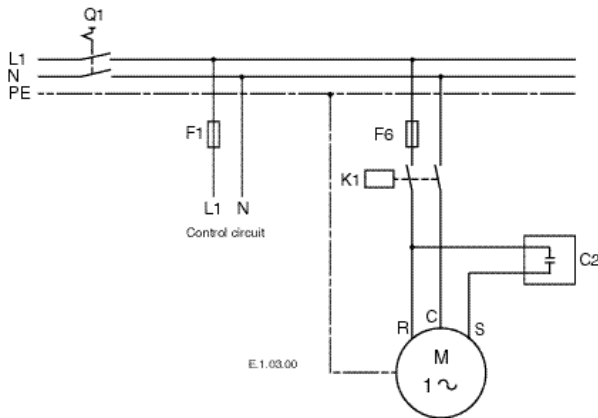

Fig. 4: Power Circuit Single-Phase

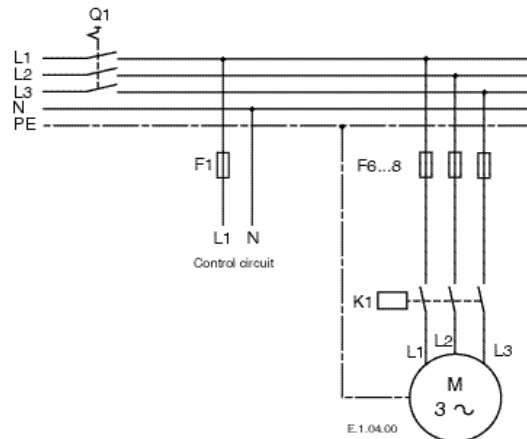

Fig. 5: Power Circuit Three-Phase

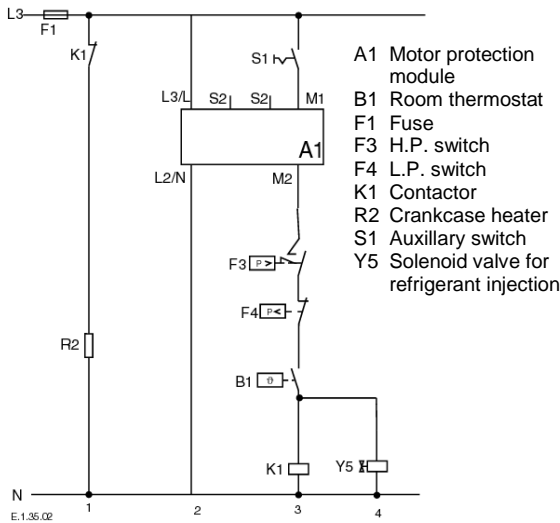

Fig. 6: Refrigeration Scroll Control Circuit

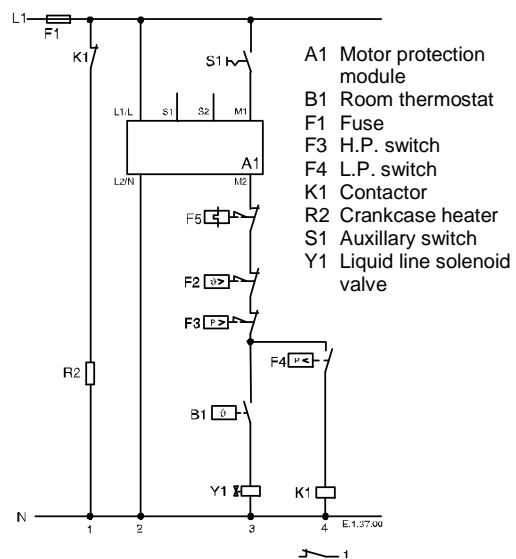
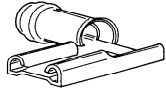

Fig. 7: Air Conditioning Scroll Control Circuit

8 Cable Connectors

The following table (Tab. 3) lists recommended types of cable connectors to be used for the various electrical terminals of the compressors and the motor protection module. “A” and “D” must fit ¼ " or 6.3 mm tab sizes. “B” and “C” are to be selected for diameters of 5mm.

Cable sizes are to be selected according to DIN ISO 0100, IEC 364 or National Regulations.



A Flag Receptacle

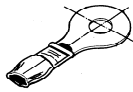

B Ring Tongue

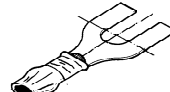

C Spade

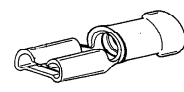

D Straight Receptacle

Air-Conditioning Scroll Compressors							Refrigeration Scroll Compressors					
Model	PFJ	TF5	TFD	TW*	TFM	Protection Module	Model	PFJ	TF5	TFD	TW*	Protection Module
ZR18-48K	A/D	A/D	A/D				ZF09-ZF11K		A/D	A/D		
ZR61K		A/D	A/D		A/D		ZS21-ZS26K		A/D	A/D		
ZR49-81K		B/C	B/C				ZB15-ZB26K	A/D	A/D	A/D		
ZR94K - ZR190K		B/C	B/C				ZF13-ZF18K		B/C	B/C		
ZR90K				B/C		A	ZS30-ZS45K		B/C	B/C		
ZR11M-19M				B/C		A	ZB30-ZB45K		B/C	B/C		
ZR250-380K				B/C		A	ZF24-ZF48K				B/C	A
ZP23-41K	A/D		A/D				ZS56-ZS11M				B/C	A
ZP24K -ZP54K					B/C		ZB56-ZB11M				B/C	A
ZP54K - ZP83K			B/C									
ZP90K - ZP182K		B/C	B/C									
Dedicated Heat Pump Scroll Compressors							Horizontal Scroll Compressors					
Model	PFJ	TF5	TFD	TW*		Protection Module	Model	PFJ	TF5	TFD	TW*	Protection Module
ZH15-26K	A/D		A/D				ZBH30-ZBH45K		A/D	A/D		
ZH30K	B/C		B/C				ZBHV45K			A/D		
ZH38-45K			B/C				ZRH49-ZRH72		B/C	B/C		
ZH56K-11M				B/C		A	ZRHV72			B/C		
ZH09KVE			A/D									
ZH13-18KVE		B/C	B/C									
ZH24-48KVE				B/C		A						

Tab. 3: Cable connectors

Note: For the Earthing connection for these compressors use a “B” Ring Tongue connection

9 Air Conditioning Scroll Compressor Wiring Diagrams

9.1 7.5 - 15 HP

ZR90K3/E to ZR19M3/E, motor codes: TWD, TW7, TWE, TWC, TWR & TW*

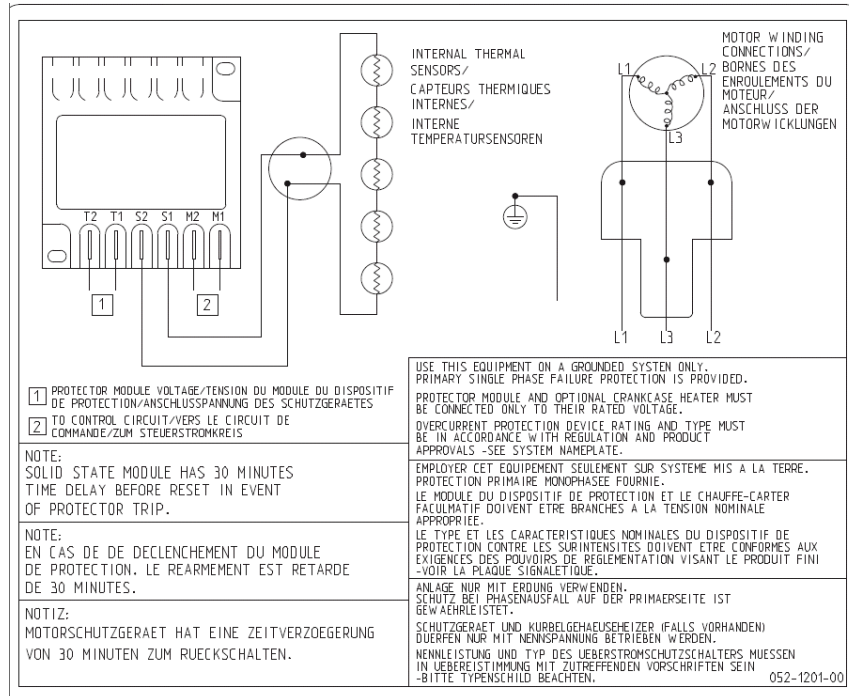

9.2 20 - 30 HP

ZR250KC/E & ZR380KC/E, motor codes: TWC, TWD & TW7

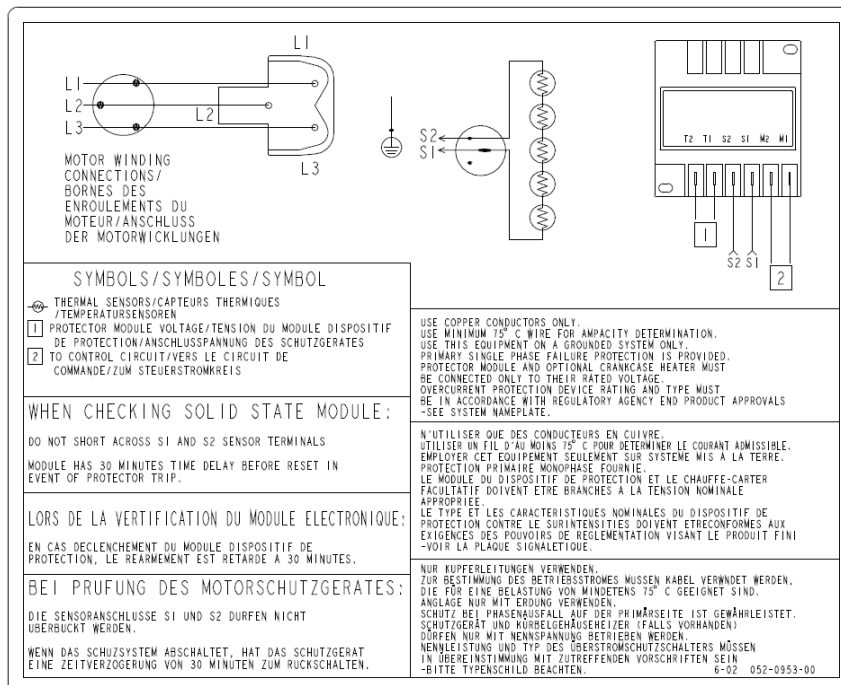

Refrigeration Scroll Compressor Wiring Diagrams

9.3 7.5 - 15 HP

ZS56K4E to ZS11M4E, ZB56K4E to ZB11M4E, ZF24K4E to ZF48K4E (ZF24K4E ECO to ZF40K4E ECO)
All compressors motor codes TWD, TW7, TWE, TWC & TWR

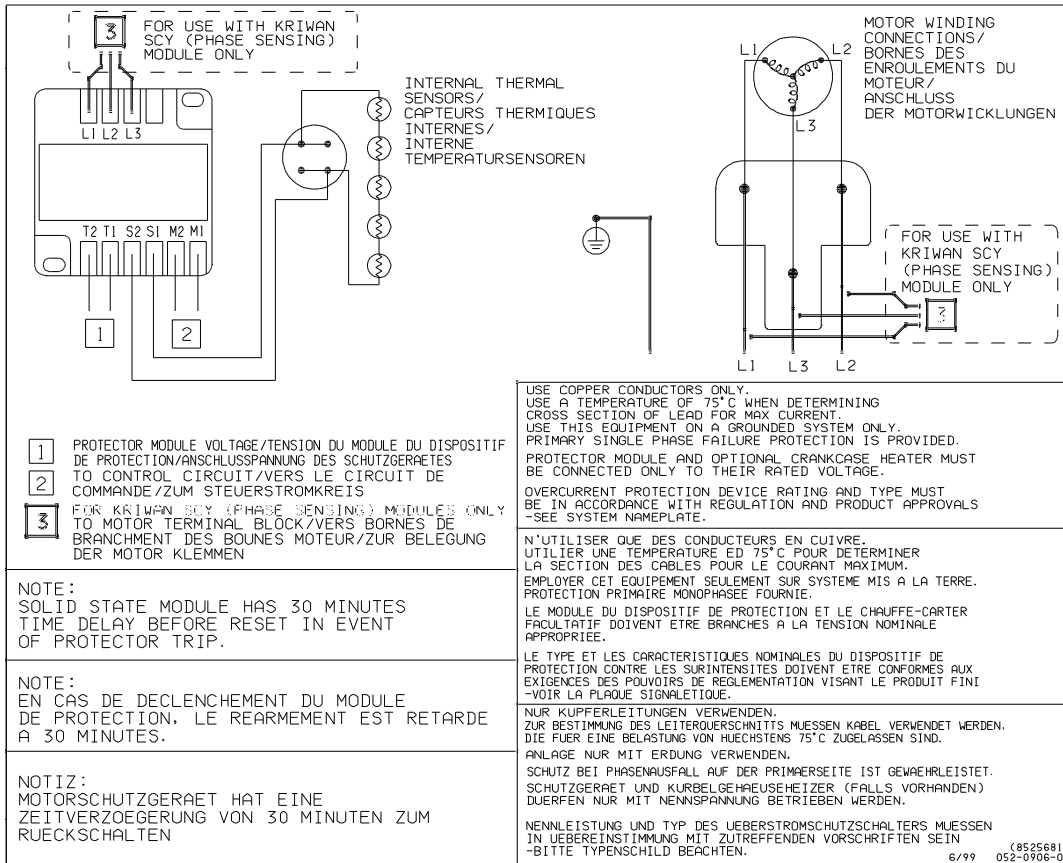

Single-Phase Moulded cover wiring diagram

9.4 1.8 - 4 HP

ZR22K3/E to ZR49K3/E & ZB19KCE to ZB26KCE, motor code: PFJ

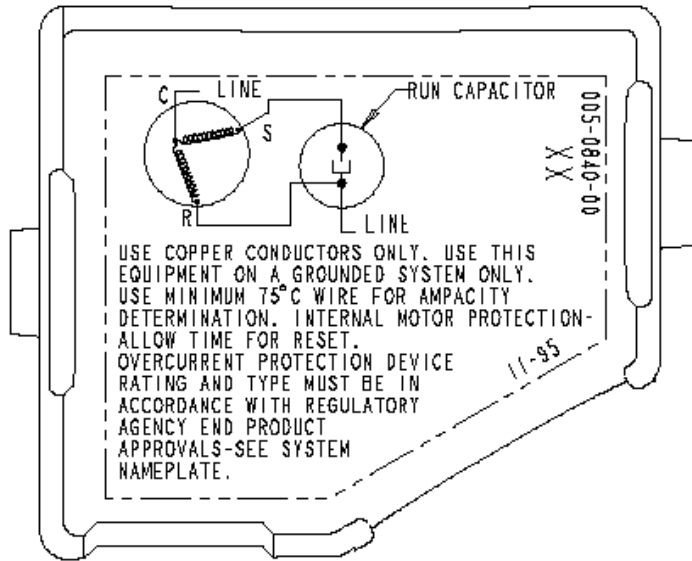

9.5 5.5 HP

ZB42KCE, motor code: PFJ

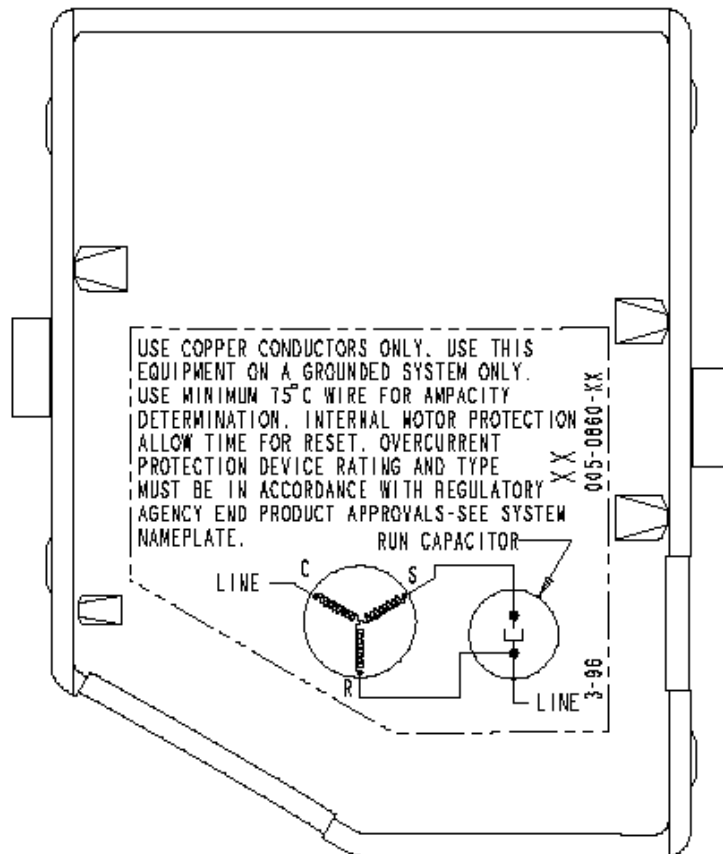

10 Copeland Scroll Compressor Three-Phase

10.1 1.8 - 4 HP

ZR22K3/E to ZR49K3/E, ZS21K4E to ZS26K4E, ZB15KCE to ZB26KCE, ZF09K4E to ZF11K4E (ZF09K4E ECO to ZF11K4E ECO), **ZR61KSE**

All compressors motor codes TFD, TF5 & TF*

USE COPPER CONDUCTORS ONLY. USE THIS EQUIPMENT ON A GROUNDED SYSTEM ONLY. USE MINIMUM 75 °C WIRE FOR AMPACITY DETERMINATION. INTERNAL MOTOR PROTECTION-ALLOW TIME FOR RESET. PRIMARY SINGLE PHASE FAILURE PROTECTION IS PROVIDED. CRANKCASE HEATER, WHEN APPLIED, MUST BE CONNECTED ONLY TO ITS RATED VOLTAGE. OVERCURRENT PROTECTION DEVICE RATING AND TYPE MUST BE IN ACCORDANCE WITH REGULATORY AGENCY END PRODUCT APPROVALS -SEE SYSTEM NAMEPLATE. TO CORRECT IMPROPER MOTOR ROTATION, SWITCH ANY TWO SUPPLY LINES.

MOTOR WINDING CONNECTION
2-94 052-1199-00

10.2 5 - 6.5 HP

ZR61K/E to ZR81K/E, ZS30K4E to ZS45KCE, ZB30KCE to ZB45KCE, ZF13K4E to ZF18K4E (ZF13K4E ECO to ZF18K4E ECO)

All compressors motor codes TFD & TF5

USE COPPER CONDUCTORS ONLY. USE THIS EQUIPMENT ON A GROUNDED SYSTEM ONLY. USE MINIMUM 75 °C WIRE FOR AMPACITY DETERMINATION. INTERNAL MOTOR PROTECTION-ALLOW TIME FOR RESET. PRIMARY SINGLE PHASE FAILURE PROTECTION IS PROVIDED. CRANKCASE HEATER, WHEN APPLIED, MUST BE CONNECTED ONLY TO ITS RATED VOLTAGE. OVERCURRENT PROTECTION DEVICE RATING AND TYPE MUST BE IN ACCORDANCE WITH REGULATORY AGENCY END PRODUCT APPROVALS -SEE SYSTEM NAMEPLATE. TO CORRECT IMPROPER MOTOR ROTATION, SWITCH ANY TWO SUPPLY LINES.

MOTOR WINDING CONNECTION
03-96 052-0880-00

11 Copeland Horizontal Scroll Compressor

ZFH09K4E to ZFH18K4E, ZBH21K4E to ZBH45K4E, ZSH21K4E to ZSH45K4E, motor codes TFD & TF5

