

Emerson Programmable Touchscreen Thermostat Installation and Operation Manual





Emerson Digital Solutions
Commercial and Residential Solutions
1065 Big Shanty Road NW, Suite 100
Kennesaw, GA 30144
770-425-2724 • 1-800-829-2724

www.climate.emerson.com

Email: ColdChain.TechnicalServices@Emerson.com

Contents

1 OVERVIEW	1
1.1. SPECIFICATIONS	1
1.1.1. <i>Technical Specifications</i>	1
1.2. TERMINAL IDENTIFICATION AND ELECTRICAL RATINGS.....	2
2 INSTALLATION	3
2.1. ENCLOSURE.....	3
2.2. THERMOSTAT LOCATION	3
2.3. THERMOSTAT INSTALLATION	4
2.3.1. <i>Opening and Closing the Thermostat Enclosure</i>	4
2.3.2. <i>Mounting the Baseplate on the Wall</i>	4
2.3.3. <i>Wires and Electrical Connection</i>	5
2.4. WIRING AND CONNECTIONS	6
2.4.1. <i>Wiring Guide - Conventional Systems (24VAC)</i>	6
2.4.2. <i>Wiring Guide - Heat Pump Systems (24VAC)</i>	7
2.4.3. <i>Thermostat – Power Terminals</i>	7
2.4.4. <i>Thermostat – Communication Terminals</i>	7
2.4.5. <i>Thermostat – Input Terminals</i>	8
2.4.6. <i>Thermostat – Output Terminals</i>	8
3 OPERATION.....	9
3.1. GRAPHICAL USER INTERFACE (GUI).....	9
3.2. CONFIGURATION MENU	9
3.2.1. <i>Configuration Menu – Modbus Device Address</i>	10
3.2.2. <i>Configuration Menu – Modbus Device Baud Rate</i>	11
3.2.3. <i>Configuration Menu – Thermostat System Configuration</i>	11
3.2.4. <i>Configuration Menu - Number of Heating Stages</i>	13
3.2.5. <i>Configuration Menu - Number of Cooling Stages</i>	14
3.2.6. <i>Configuration Menu – Full Segments Display Test</i>	16
3.2.7. <i>Configuration Menu – System Revision Display</i>	16
3.3. TEMPERATURE UNIT SELECTION	17
3.4. TIME AND DATE SETTING.....	18
3.5. MENUS & INTERFACE	19
3.5.1. <i>Temperature Setpoints</i>	20
3.5.2. <i>Thermostat Mode</i>	21
3.5.3. <i>Fan Mode</i>	22
3.5.4. <i>Fan Mode Display - Fan Status</i>	22
3.5.5. <i>Active Stage(s) Indicator</i>	23
3.5.6. <i>Schedule Mode</i>	24
3.5.7. <i>Occupancy Mode (Energy Saving Mode)</i>	26
3.5.8. <i>Manual Override</i>	27
3.5.9. <i>Screen Lock</i>	28
3.6. COMMUNICATION NETWORK	29

3.6.1.	<i>RS-485 Serial Link</i>	29
3.7.	POWER OUTAGE	30
3.8.	ADVANCED SETTINGS	30
3.8.1.	<i>Thermostat System Configuration</i>	30
3.8.2.	<i>Thermostat Stage(s) Behavior</i>	31
3.8.3.	<i>Input Settings</i>	31
3.8.4.	<i>Dehumidification Mode</i>	32
3.8.5.	<i>Economizer Mode</i>	32
3.8.6.	<i>Hold Mode</i>	33
3.8.7.	<i>Internal Temperature Offset</i>	35
3.8.8.	<i>Delay Fan</i>	35
3.8.9.	<i>Temperature Filter Time (Sampling Rate)</i>	35
3.8.10.	<i>Temperature Hysteresis</i>	35
3.8.11.	<i>Minimum Temperature Deadband (Read-Only)</i>	35
3.8.12.	<i>Temperature Minimum Setpoint</i>	35
3.8.13.	<i>Temperature Maximum Setpoint</i>	35
3.8.14.	<i>Temperature Stage Difference</i>	36
3.8.15.	<i>Compressor Min ON time</i>	36
3.8.16.	<i>Compressor Min OFF time</i>	36
4	PROGRAMMABLE TOUCHSCREEN THERMOSTAT SETUP FOR E2 AND SITE SUPERVISOR	37
4.1.	NEW INSTALLATION OF DESCRIPTION FILE TO E2	37
4.1.1.	<i>Uploading the Touch_TStat Description File to E2</i>	37
4.2.	DEVICE AND COM PORT SETUP IN E2	38
4.2.1.	<i>Modbus Device Setup</i>	38
4.2.2.	<i>E2 COM Port Setup</i>	39
4.3.	INSTALLING THE THERMOSTAT IN E2	40
4.3.1.	<i>Installing the Thermostat Application</i>	40
4.3.2.	<i>Commissioning the Thermostat</i>	40
4.4.	DEVICE AND COM PORT SETUP IN SITE SUPERVISOR.....	41
4.4.1.	<i>Modbus Device Setup</i>	41
4.4.2.	<i>Site Supervisor COM Port Setup</i>	42
4.4.3.	<i>Adding the Touchscreen Thermostat Application in Site Supervisor</i>	43
4.4.4.	<i>Installing and Commissioning the Touchscreen Thermostat</i>	43
5	TROUBLESHOOTING	45
6	REGULATORY INFORMATION	46

1 Overview

The Emerson Programmable Touchscreen Thermostat (*P/N 810-1600*) is a configurable device intended for light commercial applications. The thermostat is a communicating, intelligent sensor and controller combination with built-in temperature and humidity sensors used to control systems such as conventional Rooftop Units (RTU) and Heat Pumps (HP). The thermostat communicates over a Modbus RTU network that easily integrates with a building management system (BMS).

1.1. Specifications

1.1.1. Technical Specifications

Power Requirements	18VAC to 30VAC, 50-60Hz, less than 3.6 VA at 24VAC nominal, Class 2
Wire Size	18AWG maximum, 22AWG recommended
Relay Contact Rating	Max 1.0A per Relay, Max Total 2.0A (R, Re and C terminal)
Binary Input	Fan Proof switch input (floating or GND)
Analog Input	Designed for 10K Ω NTC thermistor
Serial Data Link	Modbus RTU on RS-485, 9600 or 19200 bps (default)
Relay Output	2C, 2H, Fan, ECO, AUX, O/B
Temperature Sensor Type	Local integrated temperature sensor, digital output (I2C)
Supported Configurations	Conventional systems, Heat-pump systems
Temperature Setting Range	32°F to 122°F (0°C to 50°C)
Temperature Accuracy	+/- 0.6°C, +/- 1.1°F, within operating temperature range
Minimum Temperature Deadband	Default value is 4°F / 2°C, between cooling and heating
Operating Temperature	32°F to 122°F (0°C to 50°C)
Storage Temperature	-4°F to 140°F (-20°C to 60°C)
Humidity Accuracy	+/- 5% @ 50% RH @ 77°F (25°C)
Humidity Display Range	0% to 95%
RTC Battery	CR1220
Compliance (USA)	Designed to comply to UL60730, FCC CFR 47 Part 15 Subpart B Class B
Compliance (Canada)	Designed to comply to E60730, Industry Canada ICES-003 Issue 6
Dimensions	H 4.72" x W 5.47" x T 1.32"
Software	V107

Table 1-1 - Technical Specifications

1.2. Terminal Identification and Electrical Ratings

Signal Name	Description	Voltage	Maximum Current Rating
C	24AVAC Power Supply Common	18-30VAC 50/60Hz	2.0A
R	24AVAC Power Supply	18-30VAC 50/60Hz	2.0A
W1	Heat Stage 1, relay output	18-30VAC 50/60Hz	1.0A
W2	Heat Stage 2, relay output	18-30VAC 50/60Hz	1.0A
AUX	Dehumidification, relay output	18-30VAC 50/60Hz	1.0A
O/B	Reversing Valve, relay output	18-30VAC 50/60Hz	1.0A
Re	24VAC Power Supply for Y1, Y2	18-30VAC 50/60Hz	2.0A
Y1	Cool Stage 1, relay output	18-30VAC 50/60Hz	1.0A
Y2	Cool Stage 2, relay output	18-30VAC 50/60Hz	1.0A
ECO	Economizer, relay output	18-30VAC 50/60Hz	1.0A
G	Fan Control, relay output	18-30VAC 50/60Hz	1.0A
GND	Reference for DC Signals		
B+	RS-485 B+ Signal		
A-	RS-485 A- Signal		
IN1	Remote 10K thermistor (Indoor)	0-3.3VDC (10K NTC)	
IN2	Remote 10K thermistor (Outdoor)	0-3.3VDC (10K NTC)	
IN3	Remote 10K thermistor (Supply)	0-3.3VDC (10K NTC)	
IN4	Remote Humidity sensor (0-5V)	0-5VDC	
IN5	Fan proof input	0VDC or floating	
GND	Reference for DC Signals		

Table 1-2 - Terminal Identification and Electrical Ratings

2 Installation

2.1. Enclosure

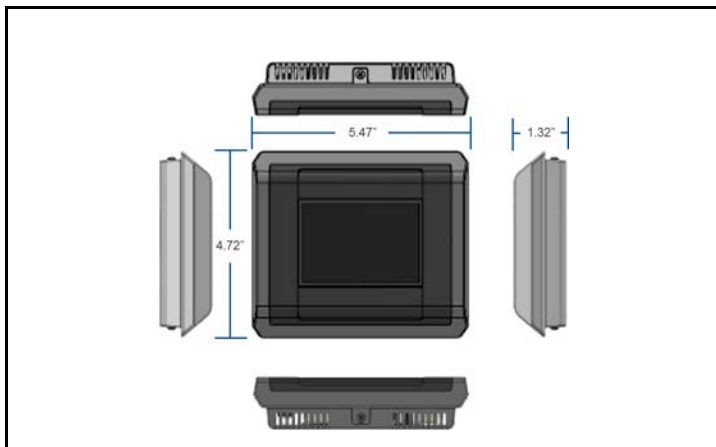

Figure 2-1 - Emerson Programmable Thermostat Enclosure

2.2. Thermostat Location

The thermostat should be mounted:

- About 5 ft (1.5 m) from the floor.
- On a part of wall without hidden pipes or ductwork.
- In a room that operating limits are within 32°F to 122°F (0°C to 50°C).
- In a room that humidity operating range is within 0% to 95% relative humidity, non-condensing.

The thermostat should not be mounted:

- Nearby a window, on an outside wall, or next to a door leading to the outside.
- Where exposed to direct light and heat from any heat source, such as a lamp, the sun, a fireplace, or any heating element which may cause a false reading (temperature measurement offset).
- Nearby a direct airflow from supply registers (air vent or duct outlet).
- In areas and locations with poor air circulation such as behind a door.

2.3. Thermostat Installation

2.3.1. Opening and Closing the Thermostat Enclosure

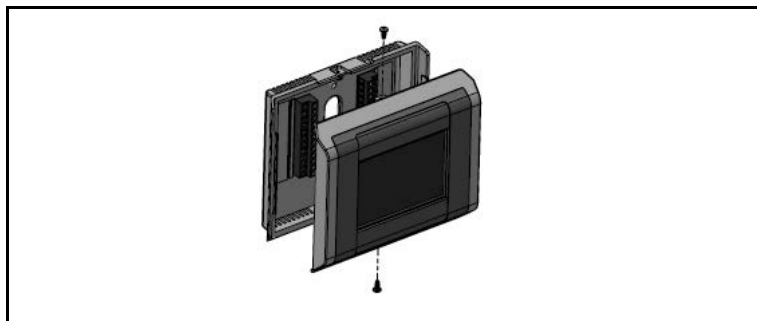

Figure 2-2 - Exploded View of Thermostat

To open the thermostat enclosure, grip the top and the bottom edge of the front part of the device and pull straight. A certain physical resistance is normal from the 24x contacts pins (terminal strips and terminal blocks) that have to be separated during the operation.

To close the thermostat enclosure, make sure to align the top and the bottom tabs between the front part and the baseplate, and then push the front part firmly toward the wall. Again, some force is required to mate both parts.



NOTE: Both top and bottom securing screws are optional and normally not installed on the units.

2.3.2. Mounting the Baseplate on the Wall

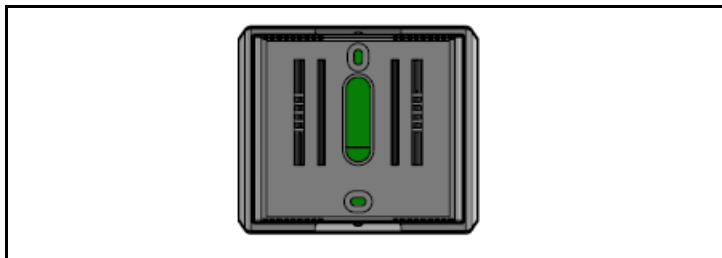

Figure 2-3 - Baseplate (Back view)

To fix the baseplate on a wall, pass the wires through the opening of the baseplate, and use either 2x self-taping screws and dry-wall anchors, or regular 6-32 machine screws to attach on a standard single-gang electrical junction box (2" x 4").



CAUTION! Do not over-tighten the screws when attaching the baseplate on a wall as physical damage may occur.



CAUTION! Keep the thermostat housing and vents clean and free of any debris to avoid malfunction of the device.

2.3.3. Wires and Electrical Connection

Once the baseplate is affixed on the wall, proceed with the wiring connections to the terminal block. Please refer to *Section 2.4., Wiring and Connections* for configuration and signals definition.

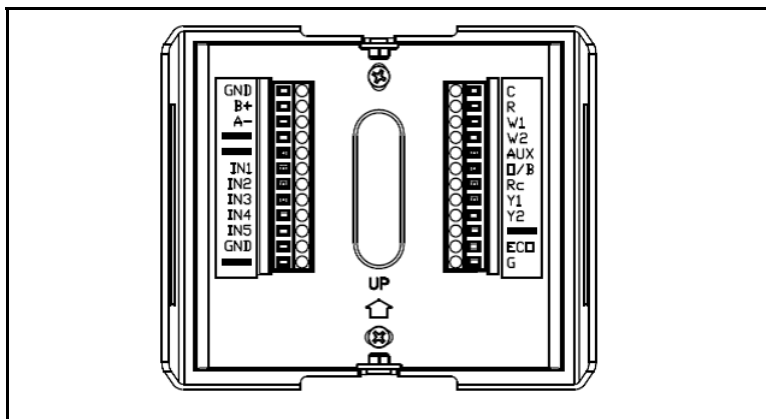

Figure 2-4 - Baseplate with Terminal Blocks Labels

2.4. Wiring and Connections



WARNING! Turn off power of the HVAC system at the main power panel or on the controlled-system itself to avoid any electrical shock or damage to the system.

2.4.1. Wiring Guide - Conventional Systems (24VAC)

Single Transformer System:

Shorting
Jumper

2H / 2C System with 1 Transformer	
R	24VAC Power Supply
Rc	24VAC Power Supply for Y1, Y2
C	24VAC Power Supply Common
Y1	Cool Stage 1, relay output
Y2	Cool Stage 2, relay output
W1	Heat Stage 1, relay output
W2	Heat Stage 2, relay output
G	Fan Control, relay output

Table 2-5 - Single Transformer System

Dual Transformer System:

2H / 2C System with 2 Transformers	
R	24VAC Power Supply
Rc	24VAC Power Supply for Y1, Y2
C	24VAC Power Supply Common
Y1	Cool Stage 1, relay output
Y2	Cool Stage 2, relay output
W1	Heat Stage 1, relay output
W2	Heat Stage 2, relay output
G	Fan Control, relay output

Table 2-6 - Dual Transformer System

For systems with only one stage, second stage terminals (Y2, W2) can be left floating (open).

2.4.2. Wiring Guide - Heat Pump Systems (24VAC)

Shorting
Jumper

2H / 2C System	
R	24VAC Power Supply
Rc	24VAC Power Supply for Y1, Y2
C	24VAC Power Supply Common
Y1	*Cool Stage 1, relay output
Y2	*Cool Stage 2, relay output
O/B	Reversing Valve, relay output
G	Fan Control, relay output

Table 2-7 - Heat Pump Systems

For systems with only one stage, second stage terminal (Y2) can be left floating (open).



***NOTE: Stage 1 and Stage 2 for Heat Pumps are Compressor Stages (Heat/Cool) and not only Cool Stages.**

2.4.3. Thermostat – Power Terminals

Thermostat Power	
R	24VAC Power Supply
Rc	24VAC Power Supply for Y1, Y2
C	24VAC Power Supply Common

Table 2-1 - Power Terminals

2.4.4. Thermostat – Communication Terminals

Modbus Connections	
A-	RS-485 A- Signal
B+	RS-485 B+ Signal
GND	Reference for DC Signals

Table 2-2 - Comm Connections

2.4.5. Thermostat – Input Terminals

Thermostat Inputs	
IN1	Remote 10K thermistor (Indoor)
IN2	Remote 10K thermistor (Outdoor)
IN3	Remote 10K thermistor (Supply)
IN4	Remote Humidity sensor (0-5V)
IN5	Fan proof input
GND	Reference for DC Signals

Table 2-3 - Input Terminals

2.4.6. Thermostat – Output Terminals

RTU System Output Terminals:

Thermostat Outputs	
Y1	Cool Stage 1, relay output
Y2	Cool Stage 2, relay output
W1	Heat Stage 1, relay output
W2	Heat Stage 2, relay output
G	Fan Control, relay output
O/B	Reversing valve, relay output
ECO	Economizer, relay output
AUX	Dehumidification, relay output

Table 2-4 - Output Terminals

3 Operation

3.1. Graphical User Interface (GUI)

The display of the device is used as the Graphical User Interface to show some of the status, setpoints and actual measurements such as room temperature and relative humidity. The display is a resistive touch-type that allows users to navigate and to change values that are shown on the display (see **Figure 3-1**).

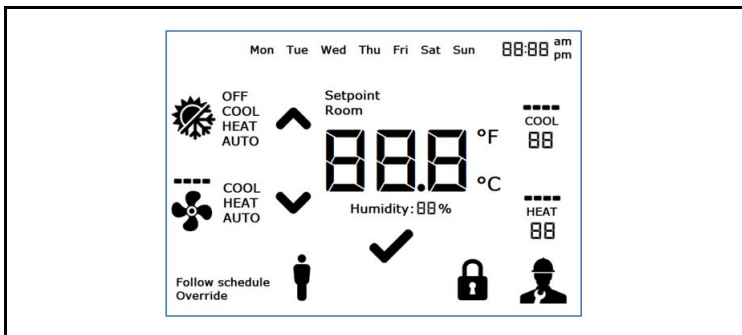

Figure 3-1 - Display With All Segments Shown

3.2. Configuration Menu

On the first start-up of the thermostat, the default System Configuration is idle. This means that the first step to get the device started is to configure the appropriate system configuration. The following menu will appear by default upon the first startup (**Figure 3-2**).

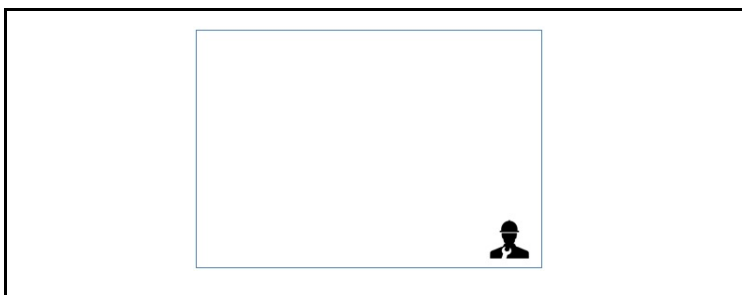



Figure 3-2 - Thermostat Display In Idle Configuration

To access the Configuration Menu (see **Figure 3-3**), press the technician  icon for 10 seconds. If the thermostat has been previously configured, to access the configuration menu from the main display, a technician icon should be displayed on the right bottom corner of the screen. The technician icon is not displayed automatically (**Figure 3-3**). To display the technician icon, touch on the right-bottom corner of the screen, and then press the technician icon  for 10 seconds.

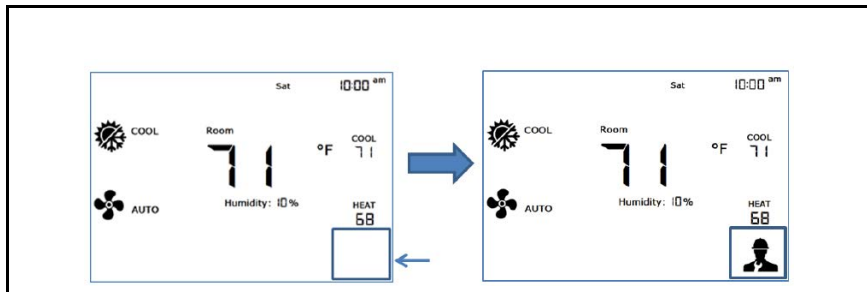

Figure 3-3 - Configuration Menu Access

3.2.1. Configuration Menu – Modbus Device Address

The first configuration menu (see **Figure 3-4**) allows users to change the Modbus device address. **Ad** is shown on the right side of the display to indicate which parameter is being changed (**Ad** stands for Address). To change the value, press either the up or down arrow, and then press the check icon to go to the next parameter. Press **CA** to cancel and exit the configuration menu without saving any changes. To change values, touch either the up or down arrow, and then touch the check icon to go to the next parameter.

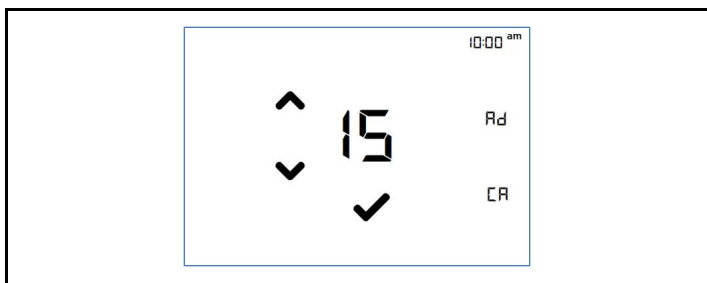

Figure 3-4 - Modbus Address Configuration Menu

Address Number	Modbus Device Address
1 to 247	Range from 1 to 247

Table 3-1 - Modbus Device Address Range

3.2.2. Configuration Menu – Modbus Device Baud Rate

The second configuration menu (see *Figure 3-5*) allows users to change the Modbus device baud rate. “br” is shown on the right side of the display to indicate which parameter is being changed (br stands for Baud Rate). To change the value, press either the up or down arrow, and then press the check icon to go to the next parameter. Press CA to cancel and exit the configuration menu without saving any changes.

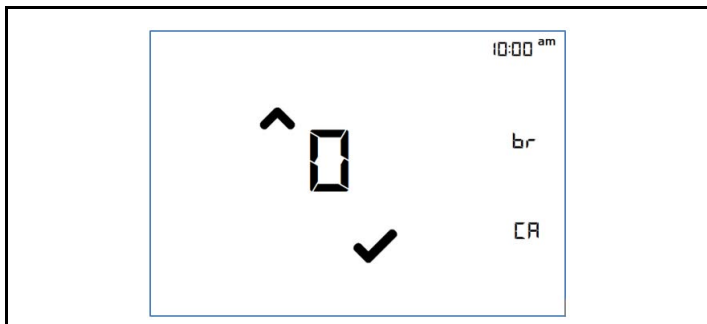

Figure 3-5 - Modbus Baud Rate Configuration Menu

Menu Option Number	Corresponding Baud Rate
0	9600 bps
1	19200 bps (default)

Table 3-2 - Modbus Baud Rate

3.2.3. Configuration Menu – Thermostat System Configuration

The third configuration menu (see *Figure 3-9*) allows users to set the thermostat system configuration. SC is shown on the right side of the display to indicate which parameter is being changed (SC stands for System Configuration). The current revision of the Emerson Programmable Touchscreen Thermostat supports Conventional HVAC Systems such as RTU and Heat-pump Systems using a reversing valve. There are 4x possible configurations: IDLE, RTU, HP_O and finally HP_B. The first system configuration is IDLE. In this configuration, all the outputs of the thermostats are open and the thermostat controls are inactive. This is to prevent any issues within the current configuration compared to the equipment connected to the thermostat. To change the value, press either the up or down arrow, and then press the check icon to go to the next parameter. Press CA to cancel and return to the normal display without saving any changes.

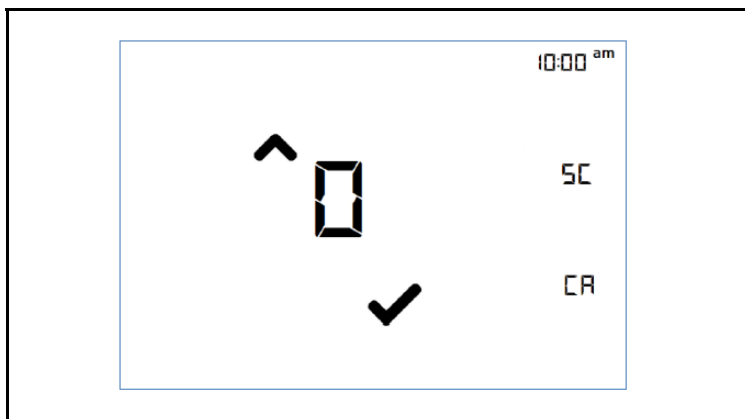

Figure 3-6 - Thermostat System Configuration Menu



NOTE: By default, the thermostat is configured as 2 heat-stages and 2 cool-stages thermostat. The number of heating/cooling stages can be changed in the subsequent menus.

- When the system is not configured, for example, configured in IDLE, all other configurations are accessible through the menu as below:

Menu Option Number	System Configuration
0	IDLE
1	RTU (Conventional Systems)
2	*HP_O (Heat-pump with O as reversing signal)
3	*HP_B (Heat-pump with B as reversing signal)

Table 3-3 - Thermostat System Configuration

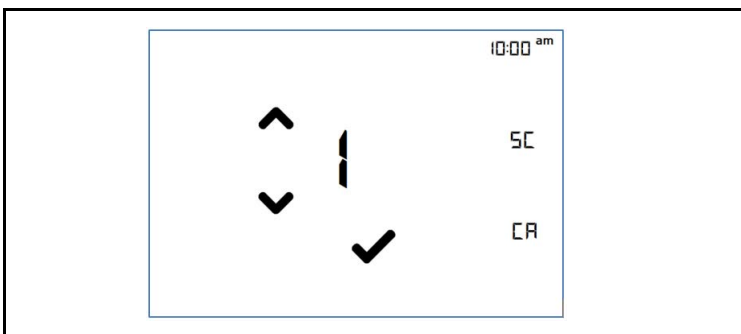

Figure 3-7 - Thermostat System Configuration Menu With Options: 0-IDLE, 1-RTU, 2-HP-O, 3-HP-B

- When the system is already configured in RTU, HP_O or HP_B, only the IDLE and the current configuration are accessible through the menu:

Menu Option Number	System Configuration
0	IDLE
(1, 2, or 3)	Current Configuration

Table 3-4 - Thermostat System Configuration



IMPORTANT! In order to change the thermostat's configuration from a functional configuration (not IDLE) to another one, the thermostat must be set to IDLE configuration first, then all configuration options will be displayed on the screen and the new desired configuration can be chosen.



IMPORTANT! A factory reset of all parameters will occur when the system is set to the IDLE configuration, except current date and time that are kept with the use of a Real-Time Clock (RTC).

3.2.4. Configuration Menu - Number of Heating Stages

For all systems, the number of heating stages can be modified inside this menu. On the screen, the letters "HS" stands for Heating Stages. Possible values are 1 heating stage, 2 heating stages (see **Figure 3-8** and **Figure 3-9**). Press the "Done" icon to move on to the next menu. Values will not be saved until the last configuration menu is reached.

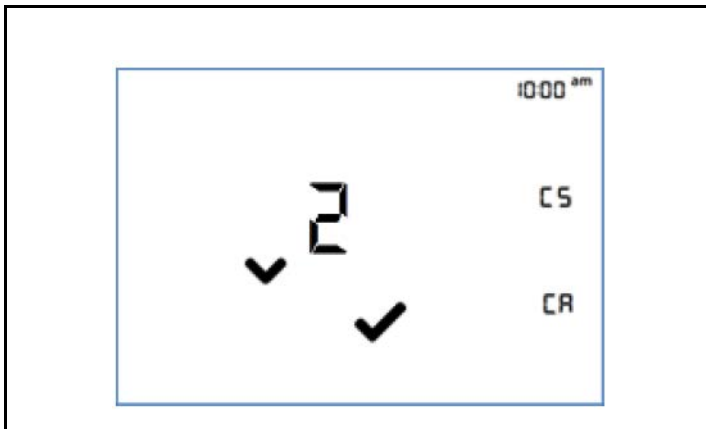

Figure 3-8 - Number of Heating Stages is Set to 2 (unsaved)

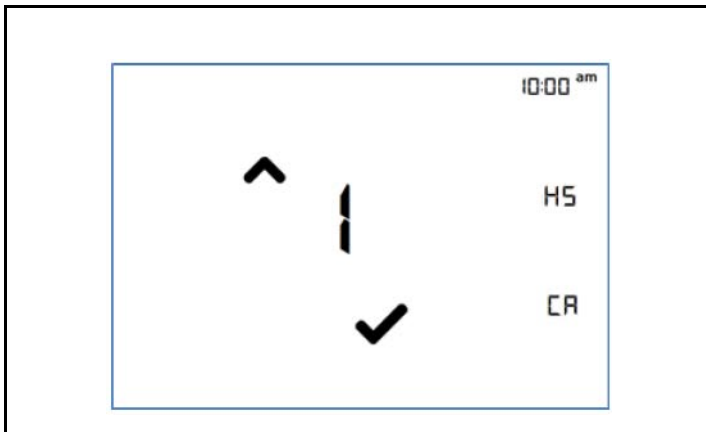

Figure 3-9 - Number of Heating Stages is Set to 1 (unsaved)

3.2.5. Configuration Menu - Number of Cooling Stages

For all systems, the number of cooling stages can be modified inside this menu. On the screen, the letters “CS” stands for Cooling Stages. Possible values are 1 cooling stages, 2 cooling stages (see *Figure 3-10* and *Figure 3-10*).

Press the “Done” icon to move on to the next menu. Values will not be saved until the last configuration menu is reached.

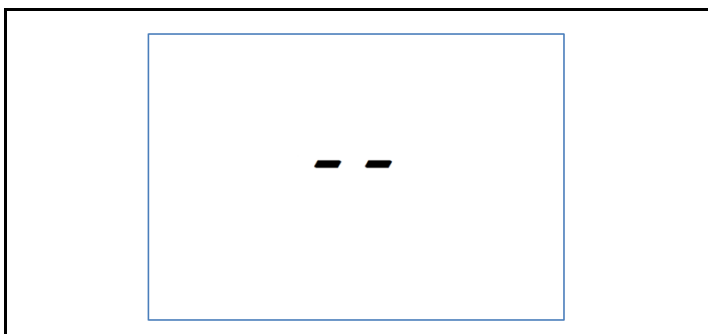

Figure 3-10 - Thermostat Display When Restarting to Occur (Rebooting)

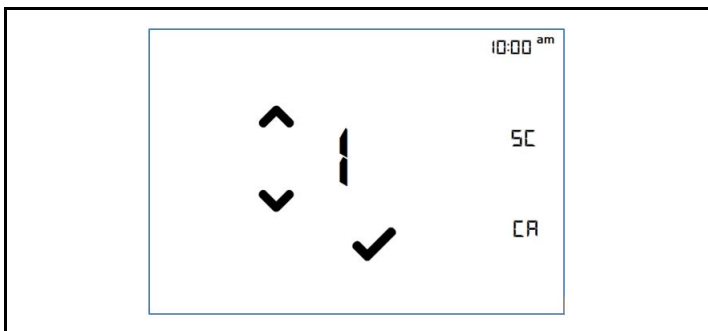

Figure 3-11 - Thermostat System Configuration Menu (New System Configuration Mode after IDLE)



IMPORTANT! To change the current system configuration to a different one, the operating system requires the system configuration is set to IDLE prior to the final configuration each time. This mechanism is to prevent any undesired operation on such an important setting.



IMPORTANT! Ensure the system configuration is selected correctly PRIOR to commissioning the device on the E2 or Site Supervisor/E3. Changing the system configuration after commissioning will result in some parameters not being able to be properly read or written. In this case the E2 or Site Supervisor/E3 application will need to be deleted and then recreated.

3.2.6. Configuration Menu – Full Segments Display Test

The fourth configuration menu (see *Figure 3-12*) allows users to test the full display segments. This allows a complete review of the display segments and to inform the user of all possible segments in the current Emerson Programmable Touchscreen Thermostat revision. Press the check icon to go to the next parameter.

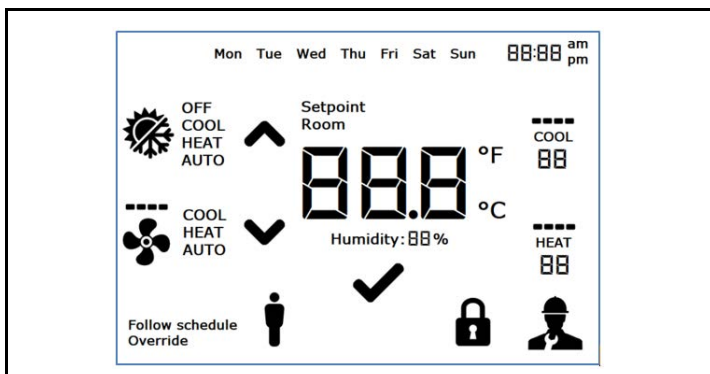

Figure 3-12 - Full Segments Display Test

3.2.7. Configuration Menu – System Revision Display

The fifth and last configuration menu (see *Figure 3-13*) provides the current system revision number. This number is shown with three digits. Note that there is no decimal after the first digit, but the revision number contains a decimal. For example, revision number 100 on the display = 1.00. The software revision will be updated for the latest official release, and will likely be higher than 1.00. Touch the letters “CA” to cancel any previous changes and go back to the normal display without saving. Press the check icon to terminate the configuration menus.

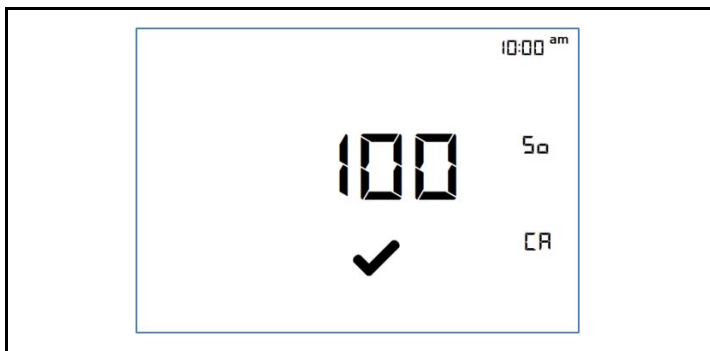

Figure 3-13 - System Revision Display (For revision 1.00)



IMPORTANT! If at least one of those parameters has been changed, the thermostat will reboot: Thermostat system configuration, number of Heating stages or number of Cooling stages.

Prior to device restart, the display will show “- -” to indicate that the device is about to reboot. (See **Figure 3-15**). When the device is rebooting, the display will turn off for approximately a few seconds until reboot operation has completed

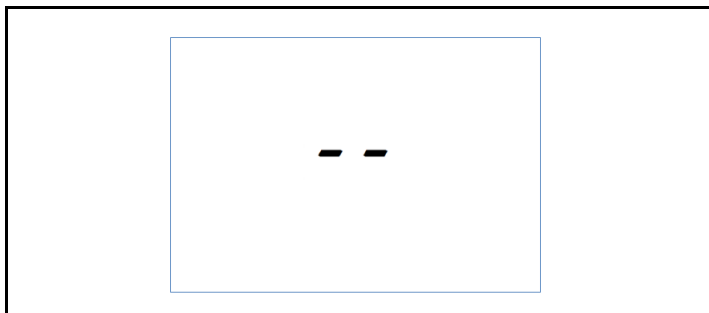

Figure 3-14 - Thermostat Display Before Reboot

3.3. Temperature Unit Selection

The temperature unit can be changed to either °F unit or °C unit. To select one or the other, press the unit indicator on the display (see **Figure 3-15**), either °F or °C. The temperature unit will toggle from one to the other each time the unit is pressed.

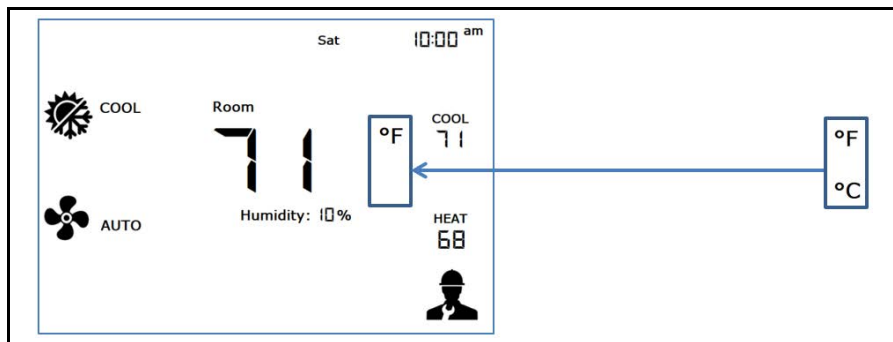

Figure 3-15 - Temperature Unit Selection

3.4. Time and Date Setting

- On the main display, the clock at top right shows the actual time. To change or update the time, press the clock on the display (see *Figure 3-16*):

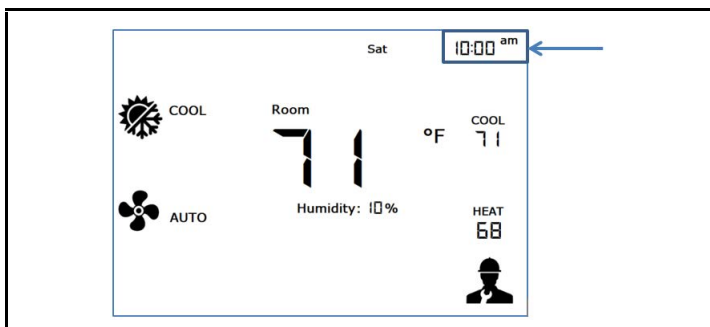

Figure 3-16 - Clock Settings

- The first step in time settings is to set the time format between 12 hours AM/PM or 24 hours. Select between H12 for 12-hours AM/PM and H24 for 24-hours format, and then press the check icon to go to the next parameter (see *Figure 3-17*). Press CA to cancel and return to the normal display without saving any changes.



IMPORTANT! If time is set through the Modbus network, the format to use for the time parameter should be 24-hours (0-23). The actual time display on the thermostat will be according to the selected time setting (12H or 24H).

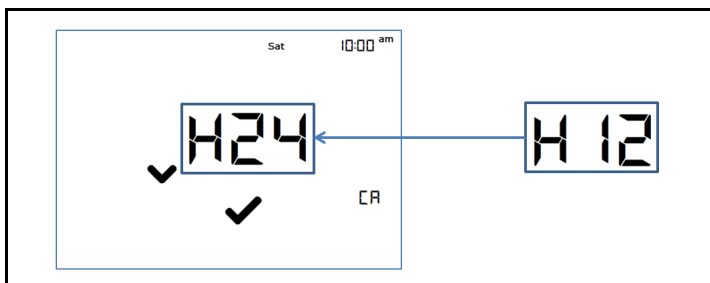

Figure 3-17 - Time Format Setting with Check Icon

- The second step (see *Figure 3-18*) is the hour field that will be flashing on the top right of the screen. To change the hours, press either the up or down arrow to the desired value, and then press the check icon to go to the next parameter.

- The third step (see *Figure 3-18*) is the minutes field that will be flashing on the top right of the screen. To change the minutes, press either the up or down arrow to the desired value, and then press the check icon to go to the next parameter.
- The last step (see *Figure 3-18*) is the day of the week that will be flashing at the top of the screen. To change the day of the week, press either the up or down arrow to the desired value, and then press the check icon to save the changes. Press CA to cancel and return to the normal display without saving any changes.

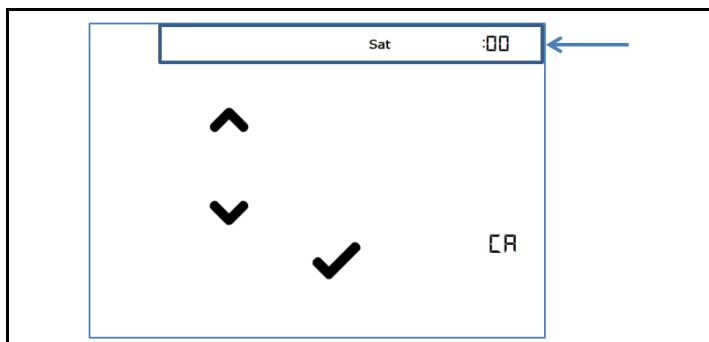

Figure 3-18 - Time and Day Settings

3.5. Menu & Interface

- The main user interface menu is shown in *Figure 3-19*:

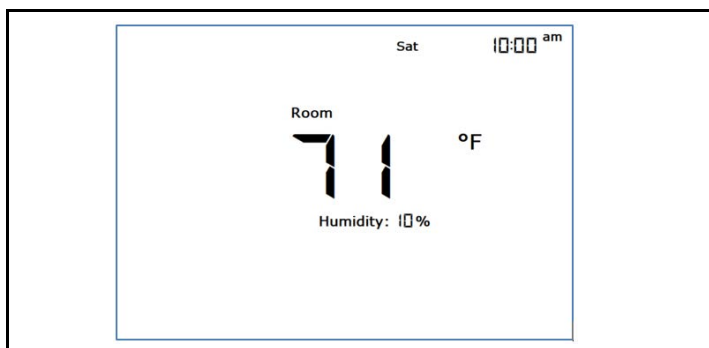

Figure 3-19 - Main User Interface (Backlight Off)

- To access or wake-up the display, press anywhere on the screen (**Figure 3-20**). Control icons will appear on both right and left side of the display. The display will return to backlight off after about 30 seconds of inactivity on the touch display. This backlight off state is essential to avoid important temperature measurement shifts due to thermostat self-heating.

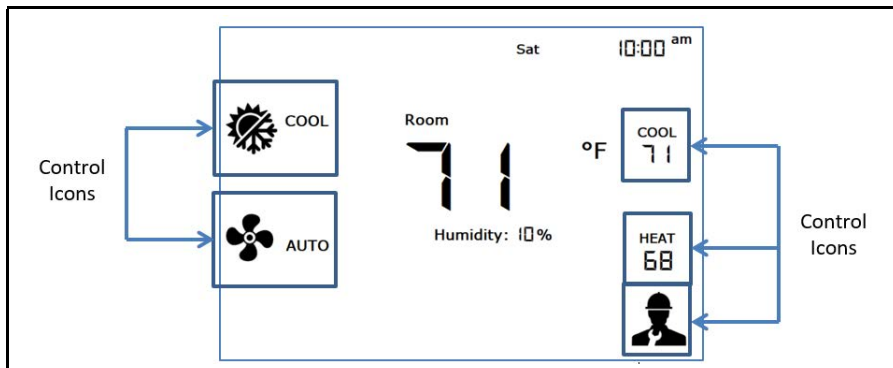

Figure 3-20 - Wake-up Display

3.5.1. Temperature Setpoints

- To change either the heating or cooling setpoint, press the desired setpoint on the right side of the display (either COOL or HEAT, see **Figure 3-21**) and the corresponding setpoint configuration menu will appear with arrows (see **Figure 3-22**).

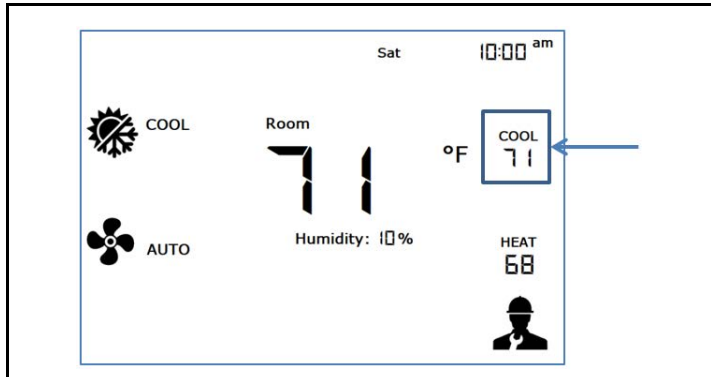

Figure 3-21 - Temperature Setpoint Access

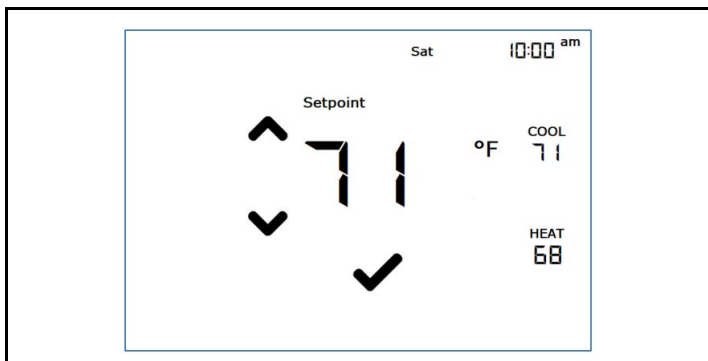



Figure 3-22 - Temperature Setpoint Menu (either COOL or HEAT)

3.5.2. Thermostat Mode

To change the Thermostat Mode, press the  icon (see *Figure 3-23*). Text on the right side of the icon will display OFF, COOL, HEAT and AUTO. The active mode will be displayed on the right side of the screen as COOL or HEAT, with the number of stages activated right above the mode (stages indicator marks, see *Section 3.5.5., Active Stage(s) Indicator*). Stages indicator marks will be displayed for the HEAT Mode, the COOL Mode, and the Fan Mode as well.

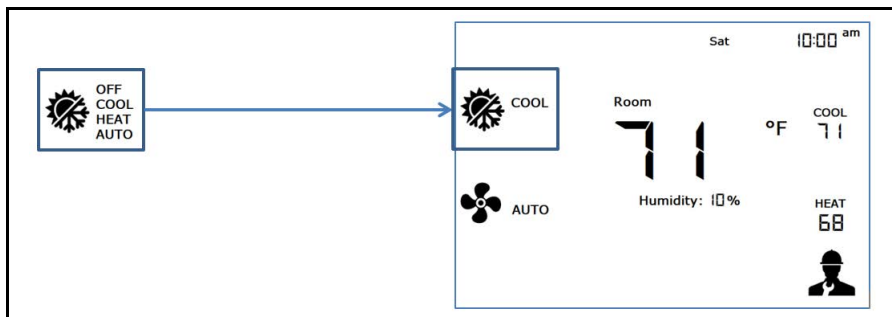



Figure 3-23 - Changing Thermostat Mode

Thermostat Mode	Description
OFF	Thermostat will be in OFF mode.
COOL	Thermostat will be in cooling mode only.
HEAT	Thermostat will be in heating mode only.
AUTO	Thermostat will be in automatic switchover mode between cooling and heating mode.

Table 3-5 - Thermostat Mode

3.5.3. Fan Mode

Fan mode can be either AUTO or ON. To change the Fan Mode, press (touch) the icon  (Figure 3-24). When the FAN_MODE is AUTO, the fan will be active only when heating or cooling call is active. While when FAN_MODE is ON, the fan stays active (ON) independently of “Thermostat mode” or heating and cooling conditions.

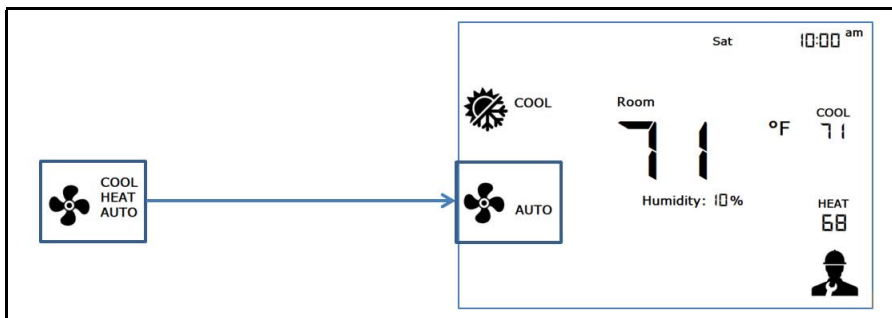

Figure 3-24 - Fan Mode Selection

3.5.4. Fan Mode Display - Fan Status

When FAN_MODE is AUTO:

- Fan icon is displayed.
- The text AUTO is displayed.
- The fan indicator (four dashes over the fan) is displayed according to heating or cooling status.



When FAN_MODE is ON:

- Fan icon is displayed.
- No text is displayed.
- The fan indicator (four dashes over the fan) will be displayed as long as the FAN_MODE is ON.





Fan Mode	Description	Output Activation	Output Display on GUI
AUTO	Fan will be activated when either cooling or heating call is active.	0% (OFF)	 AUTO
		100% (ON)	 AUTO
ON	Fan stays active (ON) independently of "Thermostat mode" or heating and cooling conditions.	100% (ON)	

Table 3-6 - Thermostat Mode

3.5.5. Active Stage(s) Indicator

The thermostat will show the mode is active with the number of activated output stages (see *Figure 3-25*), as well as the target temperature setpoint under the given active mode.

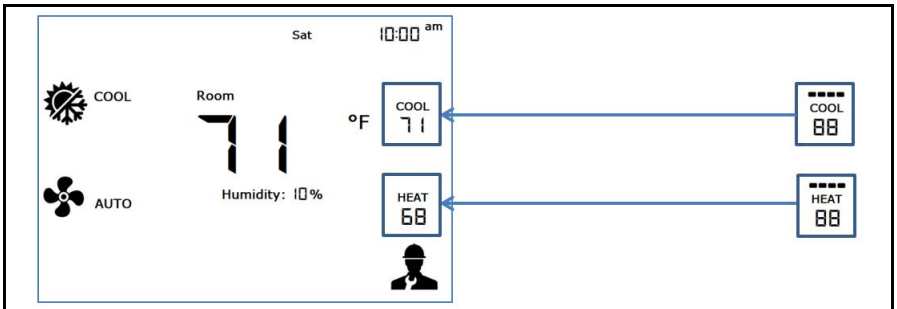

Figure 3-25 - Active Stage(s) Indicator

According to the number of output stages configured and available into the thermostat (1 to 2 stages for Cooling and Heating), the display will show output activation status according to the following table:



Stages Configuration	Output Activation	Output Display (on GUI)
2-stage Configuration (Cooling, Heating)	0% OFF	
	50% (1-stage ON)	
	100% (2-stages ON)	
1-stage Configuration (Cooling, Heating)	0% OFF	
	100% (1-stage ON)	

Table 3-7 - Active Stage Output Activation Status

3.5.6. Schedule Mode

The thermostat can operate on either a schedule or unscheduled operation.

Schedule Mode Inactive (Unscheduled Operation)

The Schedule Mode set to Inactive is the most basic mode of the thermostat. The user can change the temperature setpoints on the display, see *Section 3.1., Graphical User Interface (GUI)*. The setpoints will remain unchanged until the next manual update on the display or by Modbus.

Schedule Mode Active (Scheduled Operation)

The Schedule Mode set to Active describes the thermostat behavior against a programmed schedule. To set the Schedule Mode to Active, send a request from the BMS to enable or disable the schedule. The scheduled operation (Active) can only be activated by the Modbus network.

Scheduled operation can be done via the BMS schedule or the back-up schedule.

A) BMS schedule

If a Modbus communication to the thermostat occurs, then it is assumed that the Building Management System (BMS) controls the thermostat with its own schedule.

B) Back-up schedule

If the thermostat detects a Modbus communication loss (no communication addressed to the thermostat during 10 minutes or more), the internal schedule takes over to control the thermostat. When the internal schedule is running, the icon “Follow schedule” will be visible on the display (*Figure 3-26*). The text “Follow schedule” is not displayed in case the BMS schedule is active.

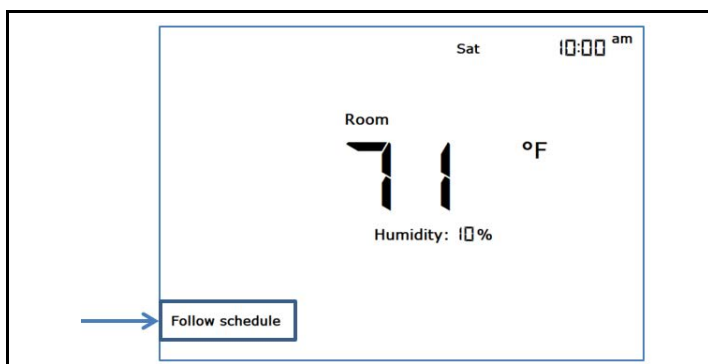

Figure 3-26 - Follow Mode Activated

The internal schedule is based on four events/periods for each day, which can be programmed on a 5 & 2 day schedule (weekdays and weekends). For each period, the Start Time, the Thermostat Mode and the Occupancy Mode are set. As described in **Section 3.5.2., Thermostat Mode**, the Thermostat Mode can be set to either OFF, COOL, HEAT or AUTO. The Occupancy Mode can be set to either Occupied or Unoccupied through the scheduler parameters (see **Section 3.5.7., Occupancy Mode (Energy Saving Mode)**). The Backup schedule is programmed (default values) as follows:

Monday to Friday (Weekdays)				Saturday and Sunday (Weekend)		
Period	Start Time	Thermostat Mode	Occupancy Mode	Start Time	Thermostat Mode	Occupancy Mode
1	6:00 AM	AUTO	OCCUPIED	6:00 AM	HEAT	UNOCCUPIED
2	12:00 PM	AUTO	OCCUPIED	12:00 PM	HEAT	UNOCCUPIED
3	6:00 PM	HEAT	UNOCCUPIED	6:00 PM	HEAT	UNOCCUPIED
4	12:00 AM	HEAT	UNOCCUPIED	12:00 AM	HEAT	UNOCCUPIED

Table 3-8 - Default Programmed Schedule

3.5.7. Occupancy Mode (Energy Saving Mode)

When the Schedule Mode is set to Follow, there are two groups of temperature setpoints, each one related to the occupancy status of the room. A given room can be either configured to Occupied or Unoccupied for a certain period of time. Normally, the Occupied Mode has setpoints that are more comfortable for the occupants, while the Unoccupied Mode brings energy savings with more conservative setpoints.

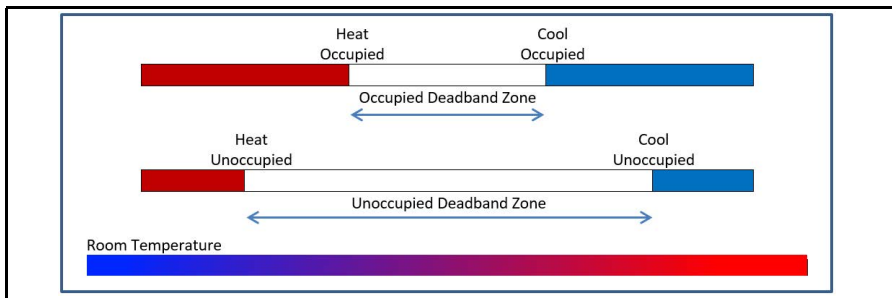

Figure 3-27 - Thermostat Occupancy Mode

When the thermostat is in Occupied Mode, a person-shaped icon will appear on the display (see **Figure 3-28**):

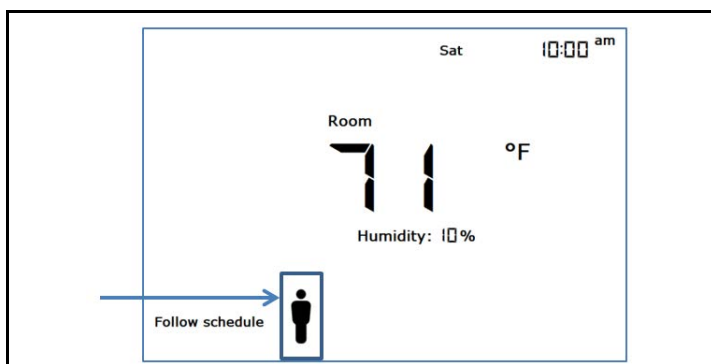

Figure 3-28 - Occupied Mode Icon on Display

3.5.8. Manual Override

Generating an override:

When the thermostat is under scheduled operation, the user can make a manual override (by the GUI) by modifying one of the following parameters:

1. Setpoint heat (occupied or unoccupied according to the active occupancy mode).
2. Setpoint cool (occupied or unoccupied according to the active occupancy mode).
3. Thermostat mode

The word “override” appears on the left-lower corner of the screen. See **Figure 3-29**:

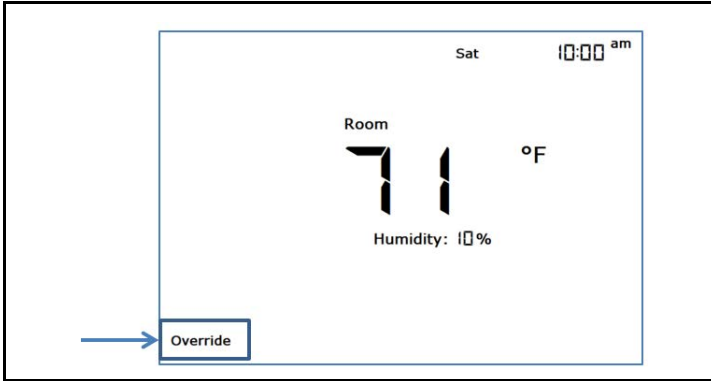

Figure 3-29 - Manual Override on Display

When at least one parameter is overridden, the following parameters cannot be modified by the BMS:

1. Setpoint heat occupied.
2. Setpoint heat unoccupied.
3. Setpoint cool occupied.
4. Setpoint cool unoccupied.
5. Thermostat mode.
6. Occupancy mode.

Resetting the override:

- 1) For both BMS schedule and Backup schedule, users can reset the override by pressing the text “override” on the GUI.
- 2) BMS can reset the override through the thermostat application. The thermostat executes the command and resets the override.
- 3) Deactivating the schedule resets the override.

Note that resetting the override is not possible if the HOLD mode is active (this applies for GUI and BMS).

When the Backup schedule is active, override resets when the next event/period is reached (for example, the programmed schedule resumes).

Current values vs scheduled values:

Scheduled values are those values that application reads from the memory and will be used according to the schedule. Override values are not stored in memory, and are used for certain periods according to the needs of the user. In all times, the Modbus registers hold the current values that are used by the thermostat.

Override status:

BMS can read the OVERRIDE STATUS to verify if override is taking place or not. (This applies only for the BMS schedule). Intuitively, if BMS communicates with the thermostat, the Backup schedule is automatically inactive.

NOTE:

When an override is taking place, it stays in the following conditions:

- 1) Override stays if BMS schedule becomes inactive and Backup schedule becomes active due to loss of communication between thermostat and BMS.
- 2) Override stays if Backup schedule becomes inactive and BMS schedule becomes active due to re-establishment of communication between thermostat and BMS.
- 3) In case of Backup schedule, override stays as long as Hold mode is active and the next event/period is reached (HOLD mode has been activated while override is taking place).

3.5.9. Screen Lock

The touchscreen of the thermostat can be locked. Screen can be locked completely or partially. When the screen is completely locked, the user cannot modify any parameter on the screen. When the screen is partially locked, the user can only modify the setpoints and nothing else. The Screen Lock function can only be accessed remotely through the Modbus network interface. The Screen Lock options are:

- Lock the screen completely
- Lock the screen partially (can adjust temperature setpoints)
- Unlock the screen

When the screen is completely locked, a lock icon will appear on the screen (see **Figure 3-30**). While the screen is partially locked, if something other than setpoints is touched or pressed, the lock icon will appear for short time (approximately one second) to indicate that the touched button is locked.

If communication with the BMS is lost while the screen is locked, the thermostat waits up to 10 minutes before auto-unlocking the screen (users have all-access). If communication between BMS and the thermostat is re-established, the BMS needs to send the lock request in order to lock the screen again.

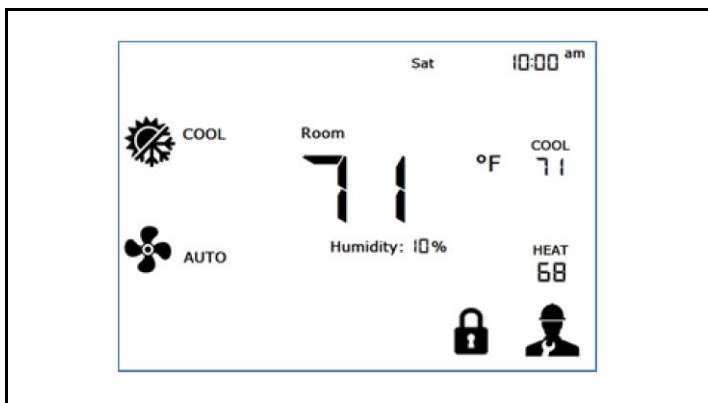

Figure 3-30 - Locked Screen with Lock Icon

3.6. Communication Network

3.6.1. RS-485 Serial Link

The thermostat is equipped with a RS-485 serial data link to communicate with the BMS. Communication with the Emerson Programmable Touchscreen Thermostat is performed via the Modbus RTU protocol over the RS-485 link. The Modbus network is used to read the status of the thermostat and/or apply new settings to modify its operation.

There are three (3) switches (DIP switch) that allow enabling or disabling some termination and bias resistors for the proper function of the RS-485 network (see *Figure 3-31*). These switches are located on top-right corner when the thermostat enclosure is open.

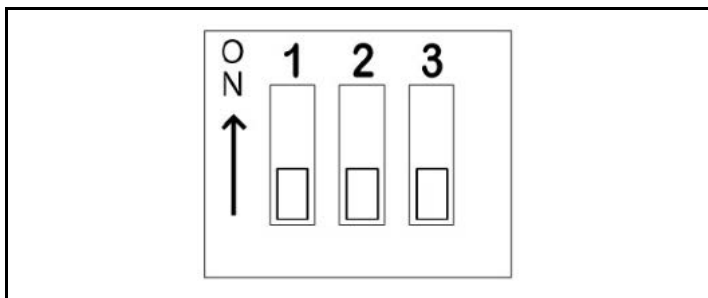

Figure 3-31 - Modbus RS-485 Network Configuration Switches

Switch #1: Pull-up resistor enable (PU+)

This switch provides the ability to add a pull-up resistor (510 Ohms) on the RS-485 network for bias purposes. Normally, this switch is in the OFF position (no pull-up resistor on the network).

Switch #2: End of Line resistor enable (EOL)

This switch provides the ability to add a termination resistor (120 Ohms) on the RS-485 network for termination purposes. If you do have a termination resistor elsewhere on your network setup, put this switch in the OFF position. If you do not need a termination resistor from the thermostat, put this switch in the ON position.

Switch #3: Pull-down resistor enable (PD-)

This switch provides the ability to add a pull-down resistor (510 Ohms) on the RS-485 network for bias purposes. Normally, this switch is in the OFF position (no pull-down resistor on the network).

3.7. Power Outage

In case of a power outage, the last settings of the thermostat are kept in volatile memory and retrieved upon power restore. The only exception not stored in non-volatile memory is the Manual Override Mode (see **Section 3.5.8., Manual Override**). The thermostat is equipped with an RTC (Real-Time Clock) device that is connected to a backup battery. This lithium coin cell battery only maintains time and date in the unlikely event of a power outage. The expected lifetime of the battery is seven (7) years.

3.8. Advanced Settings

3.8.1. Thermostat System Configuration

Default Value: IDLE

The thermostat can control different types of HVAC equipment, and is configured accordingly by the thermostat control configuration. The supported types are Conventional Systems such as Rooftop Units (RTU) and Heat-pump Systems (HP). To prevent any damage to the system upon first boot-up sequence of the thermostat, once installed, the default control configuration is IDLE, which means that all outputs are set in floating state to prevent any equipment issue.

	Stage	IDLE (Default)	RTU (Roof-Top Unit) Conventional System	HP_O (Heat-pump)	HP_B (Heat-pump)
Heat	1	-	W1	Y1	Y1+B
Activated	2	-	W1+W2	Y1+Y2	Y1+Y2+B
Cool	1	-	Y1	Y1+O	Y1
Activated	2	-	Y1+Y2	Y1+Y2+O	Y1+Y2

Table 3-9 - Thermostat Configuration

3.8.2. Thermostat Stage(s) Behavior

Figure 3-32 below briefly describes the behavior of the thermostat according to the room temperature, setpoints, and stage(s) that is or are activated.

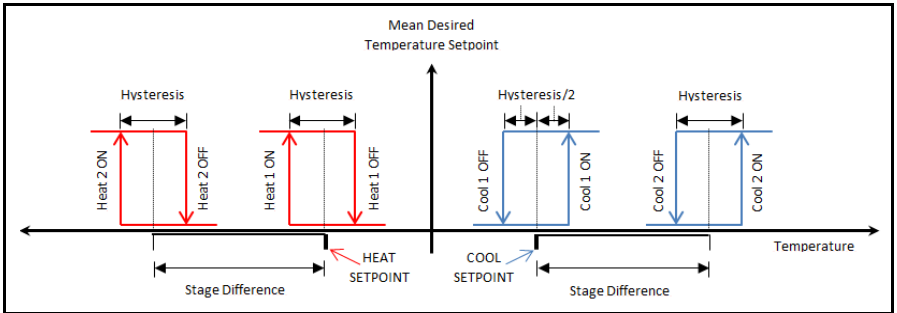

Figure 3-32 - Thermostat Behavior



CAUTION! The **DEAD BAND MINIMUM**, **HYSTERESIS** and **STAGE DIF** parameters have write access. A special precaution must be taken in this case because these parameters are often linked together and some interference could occur if those parameters are not set properly.

3.8.3. Input Settings

There are 5 inputs terminal (IN1 to IN5) that can be configured. Each input terminal has MODE, STATE and OFFSET Modbus parameters. Also, IN1 has a supplementary WEIGHT Modbus parameter. These configuration registers will affect the INPUT VALUE and CONTROL TEMPERATURE Modbus registers.

INPUT INx MODES	
Digital	Local terminal connected to a digital switch.
Thermistor	Local terminal connected to a thermistor.
0-10V	Local terminal connected to 0-10V voltage.

Table 3-10 - Input In Modes

Input modes are configured to the following settings and are read only.

- IN1 = Thermistor (used for the Indoor temperature)
- IN2 = Thermistor (used for the Outdoor temperature)
- IN3 = Thermistor (used for the Supply Air temperature)
- IN4 = 0-10V (Used for a Remote Humidity sensor)
- IN5 = Digital (used for a Fan proof input)

Although the input can accept up to 10V voltage, the IN4 has been adapted for a 0-5V sensor. So, 0 = 0%RH and 5V = 100%RH.

INPUT IN _x STATE	
OFF	The input is not used.
LOCAL	The thermostat updates the INPUT VALUE (IN _x) with the value provided by the corresponding local IN _x terminal.
REMOTE	The network updates the INPUT VALUE (IN _x) with the value provided by Modbus.

Table 3-11 - Input In State

INPUT IN _x STATE	
INPUT IN _x OFFSET	Offset added to the input terminal when the IN _x STATE is LOCAL. When the IN _x STATE is REMOTE, the OFFSET is not used.
INPUT VALUE (IN _x)	In LOCAL state, this is the corresponding terminal IN _x value with the applied offset. In REMOTE state, this is the value written by the Modbus network.
CONTROL TEMPERATURE	CONTROL TEMPERATURE is updated according to a relationship between the thermostat internal temperature and the INPUT VALUE (IN1). The formula used to get the value is $WEIGHT \times IN1 + (1-WEIGHT) \times \text{Internal Temperature}$. This is used by the thermostat algorithm (stage, economizer, display).
INPUT WEIGHT IN1	Value used in the CONTROL TEMPERATURE calculation.

Table 3-12 - Input In State

3.8.4. Dehumidification Mode

When DEHUMIDIFICATION MODE is set to ON, if the current humidity measure is equal or higher than the DEHUMIDIFICATION RH SETPOINT, the AUX output relay is activated. If the current humidity measure is lower than the DEHUMIDIFICATION RH SETPOINT, the AUX output relay is deactivated.

When the DEHUMIDIFICATION MODE is set to OFF, the AUX output relay is always deactivated.

NOTE: Note that there is no information on the status of the dehumidification on the display.

3.8.5. Economizer Mode

The ECONOMIZER mode is used to cool the room with fresh outdoor air instead of air cooled by the compressor when possible to save energy.

To allow the Economizer mode to be activated, the following conditions must be reached:

- The ECONOMIZER ENABLE must be enabled.
- The thermostat mode must be AUTO or COOL.

- The outdoor temperature (IN2) must be below the ECONOMIZER CHANGEOVER SETPOINT value.
- The outdoor temperature (IN2) must be below the room temperature.
- The Supply Air temperature (IN3) must be above the ECONOMIZER SUPPLY AIR TEMPERATURE SETPOINT value.

When the Economizer mode is activated, the FAN and ECO output relays are energized until SET POINT COOL is reached.

Pre-occupancy Purge

The pre-occupancy purge is used only when the schedule is active. The thermostat energizes the FAN and ECO relay outputs a period of time before a transition from unoccupied to occupied. This period is determined by the ECO PRE-OCCUPANCY PURGE_PERIOD.

To allow the pre-occupancy purge to be activated, the following conditions must be reached:

- The ECONOMIZER ENABLE must be enabled.
- The scheduler must be enabled.
- The ECO PRE-OCCUPANCY PURGE_PERIOD must be different than OFF.

NOTE: Note that there is no information on the status of the economizer on the display.

3.8.6. Hold Mode

Users can hold the following parameters and prevent them from being changed on the screen or by the BMS:

Setpoint heat (occupied and unoccupied), set point cool (occupied and unoccupied), thermostat mode, occupancy mode and fan mode.

The HOLD function can be activated only when the schedule is active. When HOLD function is active, BMS cannot disable the schedule itself nor reset the override.

The HOLD function can be fixed for 1,2,3, or 4 hours.

To activate the HOLD mode:

1. Press the room temperature digits and the menu will be displayed.
2. Use the arrows UP and DOWN to set the time of HOLD (*Figure 3-33*).
3. Press the “Done” icon to confirm and exit.
4. In the main display, the word “HOLD” will be displayed on the upper-right corner of the screen (replaces the time digits).

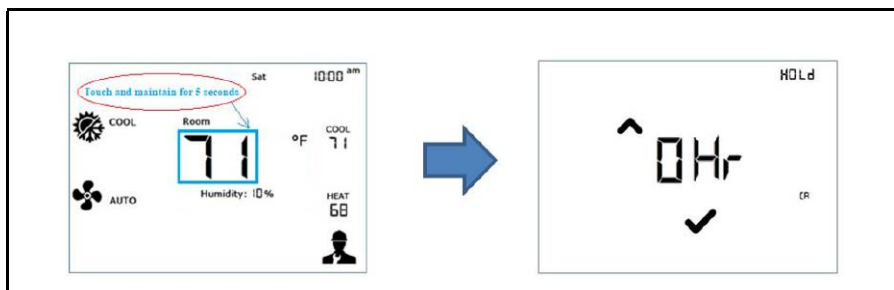

Figure 3-33 - Setting the Hold Function

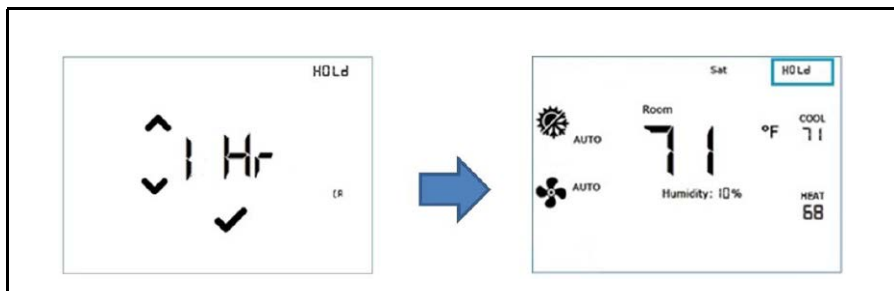

Figure 3-34 - Hold Function When Activated

To deactivate the HOLD mode:

1. Press the room temperature digits, the Hold menu will be displayed.
2. Use the DOWN arrow to set the time of HOLD to zero.
3. Press the “Done” icon to confirm and exit.
4. In the main display, the word “HOLD” will disappear.

The BMS can verify if HOLD mode is active or inactive.

3.8.7. Internal Temperature Offset

Default Value: 30.74°F (-0.7°C)

Temperature offset applied to the internal temperature measurement.

3.8.8. Delay Fan

Default Value: 60 seconds

Time delay before stopping the fan after heating or cooling stages turn off.

3.8.9. Temperature Filter Time (Sampling Rate)

Default Value: 60 seconds

Temperature Filter Time is the time constant on the temperature measurement. (Time base for the software sampling, with four (4) samples required to get the filtered value).

3.8.10. Temperature Hysteresis

Default Value: 33.8°F (1°C)

Temperature hysteresis is the temperature difference between activation and deactivation of an output stage (either the cooling or heating) during normal operation.

3.8.11. Minimum Temperature Deadband (Read-Only)

Default Value: 35.6°F (2°C)

Minimum temperature deadband between heat and cool setpoints. This deadband feature prevents the thermostat to send heat and cool activation simultaneously. When the temperature measurement of the room is within this zone (between heat and cool setpoints), then no output stage is activated.

3.8.12. Temperature Minimum Setpoint

Default Value: 59°F (15°C)

Minimum allowable temperature setpoint for a user.

NOTE: This parameter is set through network and is not accessible on the display of the thermostat.

3.8.13. Temperature Maximum Setpoint

Default Value: 77°F (25°C)

Maximum allowable temperature setpoint for a user.*

3.8.14. Temperature Stage Difference

Default Value: 33.8°F (1°C)

Temperature difference between engagement of stage 1 and stage 2, for both heating and cooling mode.

3.8.15. Compressor Min ON time

Default Value: 0 seconds

Once activated by the thermostat algorithm, the compressor output (Yx) will be kept activated for a minimum period equivalent to Min ON time parameter.

3.8.16. Compressor Min OFF time

Default Value: 0 seconds

Once deactivated by the thermostat algorithm, the compressor output (Yx) will be kept deactivated for a minimum period equivalent to Min OFF time parameter.

4 Programmable Touchscreen Thermostat Setup for E2 and Site Supervisor

E2

4.1. New Installation of Description File to E2

4.1.1. Uploading the Touch_TStat Description File to E2

The Touchscreen Thermostat requires adding a description file (P/N 527-0729) to E2. Contact Customer Service to obtain this information:

Solutions.CustomerService@Emerson.com

NOTE:  Software must be installed to perform a description file upload.

1. Connect to E2 using UltraSite32 (refer to the *UltraSite32 Manual P/N 026-1002*).
2. Expand UltraSite to view **Directory Level** and **Site Level** see *Figure 4-1*.
3. Right-click **Site Level** and click **Connect**.
4. Expand **Site Level** and locate the E2 Unit where the *Touch T-Stat.dsc* will be installed.
5. Right-click on the unit and select **Upload Description File**

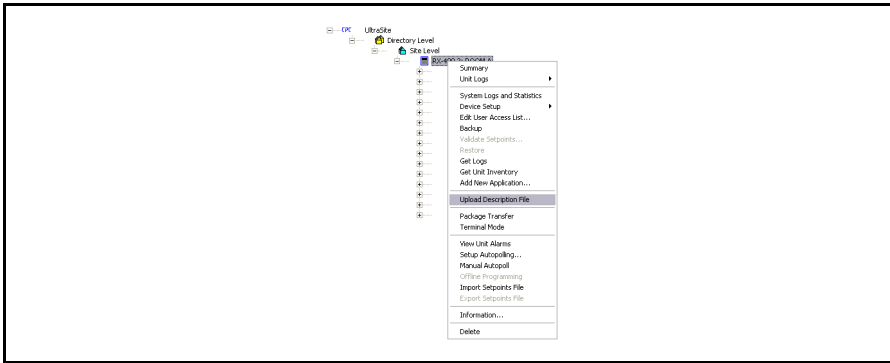

Figure 4-1 - Upload Description File

- Click **Browse** and select the appropriate description (*.dsc) file for **Touch T-Stat.dsc** from the computer and click **Open**

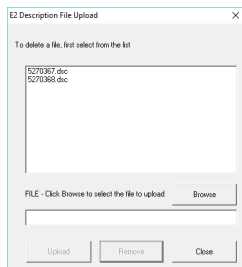

Figure 4-2 - E2 Description File Upload

- Click **Upload**. A window will display that the description file was successfully imported. Click **OK**. The description (*.dsc) file should appear in the list.
- Once completed, disconnect from the E2 and reboot the E2 controller - either manually with the toggle switch or remotely through Terminal Mode.

NOTE: DO NOT omit the step of rebooting the controller:

4.2. Device and COM Port Setup in E2

4.2.1. Modbus Device Setup

The RS-485 line of the transmitter is isolated from the power supply. A separate ground reference terminal (GND) is provided for the RS-485 connection.

If you are using the shielded cable, the Shld terminal can be used to hold the exposed part of the shield. Note that the Shld terminal is floating (not electrically connected).

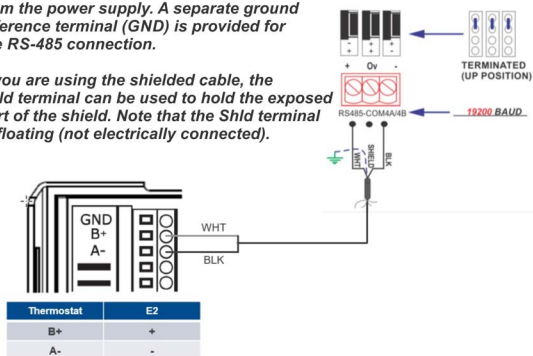



Figure 4-3 - E2 Network Connections

4.2.2. E2 COM Port Setup

1. Log into the E2 by pressing .
2. Press  then **3**, **7**, **1** to access General controller Info.
3. Press **F2** twice to move to C3: Serial tab (*Figure 4-4*).

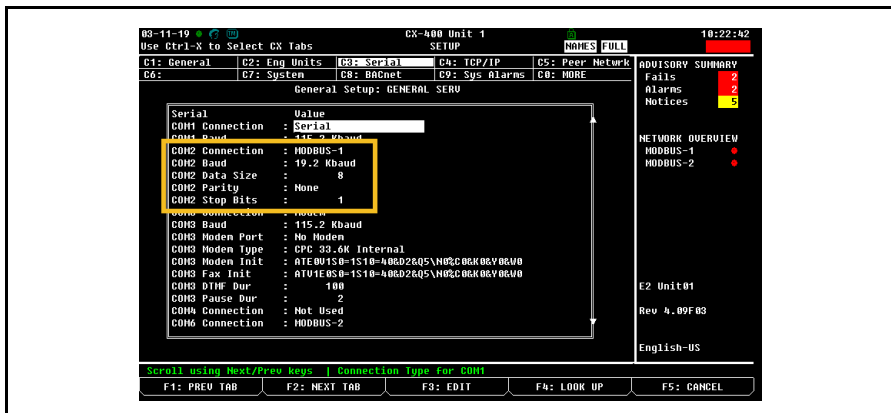







Figure 4-4 - C3: Serial Tab

4. Press the  to select the Com Port that the device is wired to (COM2, COM4 or COM6).
5. Press **F4** for LOOK UP and select MODBUS-1, MODBUS-2 or MODBUS-3.
6. Press  to set configuration.
7. Set the MODBUS connection as follows:
8. Press **F4** to select options and press e to set the configuration.
 - Com Baud: 19.2 Kbaud
 - Com Data Size: 8
 - Com Parity: None
 - Com Port Stop Bits: 1
9. Press  to set the configuration.
10. Press  to save changes.
11. Press  to return to the Home screen.

4.3. Installing the Thermostat in E2

4.3.1. Installing the Thermostat Application

1. Press **Menu**, **7**, **7**, **2** to enter **Connected I/O Boards and Controllers**.
2. Press **F2** once to move to **C3: ECT** tab. Highlight the application **Tch T-Stat** and enter the desired number of devices under **Quantity** up to **6**.

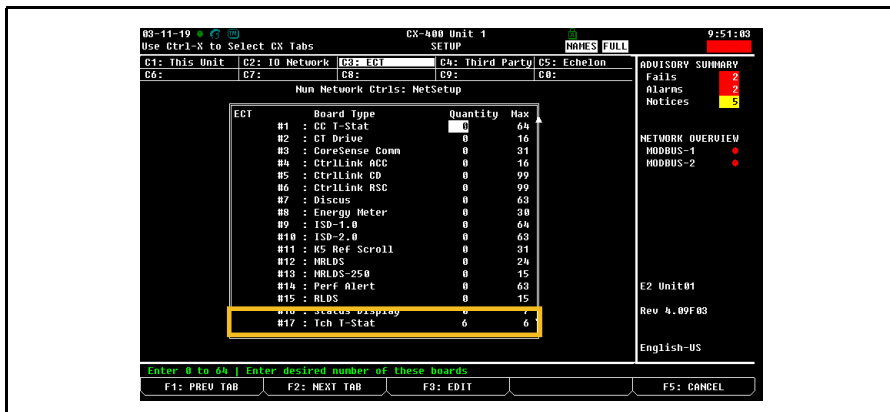

Figure 4-5 - C3: ECT Tab

4.3.2. Commissioning the Thermostat

1. Press **7**, **7**, **Menu**, **1** to enter the **Network Summary** screen.
2. Highlight the **Tch T-Stat001** to be commissioned by pressing the down arrow and then **F4**.
3. A window with **Select Network** appears on the screen, select the Modbus number where you configured the device and press **Enter**.
4. Select the address for the device and press **Enter**. Default for the device is **1**.



IMPORTANT! Ensure the system configuration is selected correctly **PRIOR** to commissioning the device on the E2 or Site Supervisor/E3. Changing the system configuration after commissioning will result in some parameters not being able to be properly read or written. In this case the E2 or Site Supervisor/E3 application will need to be deleted and then recreated.

5. A window will appear. Press  and a confirmation will show **MODBUS Device Address is set**.



Figure 4-6 - Modbus Device Address is Set

NOTE: Refer to **Section 3.2.1**, to set the Device Address on the thermostat.

Site Supervisor

4.4. Device and COM Port Setup in Site Supervisor

4.4.1. Modbus Device Setup

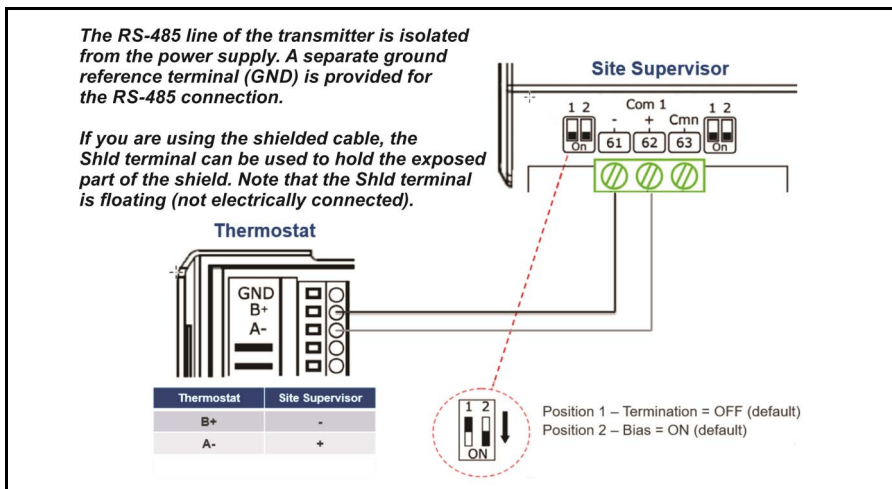

Figure 4-7 - Modbus Device Setup for Site Supervisor

NOTE: The polarity of the MODBUS connection between Site Supervisor and Touchscreen Thermostat is reversed.

4.4.2. Site Supervisor COM Port Setup

1. Click the Settings icon (the gear)  and select **General System Properties**.

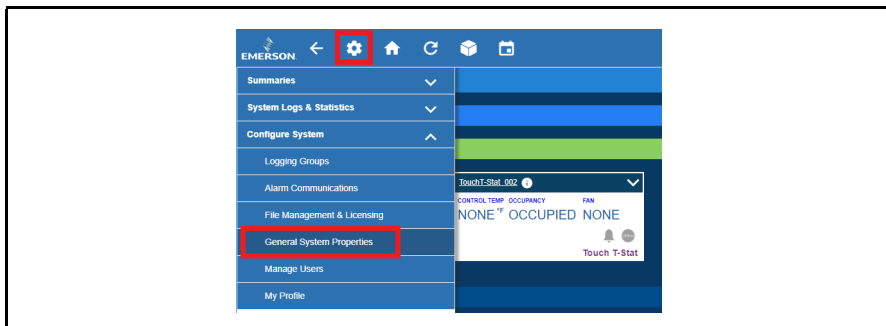

Figure 4-8 - General System Properties

2. Select the Com Port the device is wired to (**Com Port 1 - 4**).
3. Select the available Modbus (**Modbus-01 - Modbus-04**).
4. Set the Modbus connection as follows:
 - **Com Port Baud:** 19.2 Kbaud
 - **Com Port data size:** 8
 - **Com Port Parity:** None
 - **Com Port Stop Bits:** 1
5. Click **Save** to save the changes.

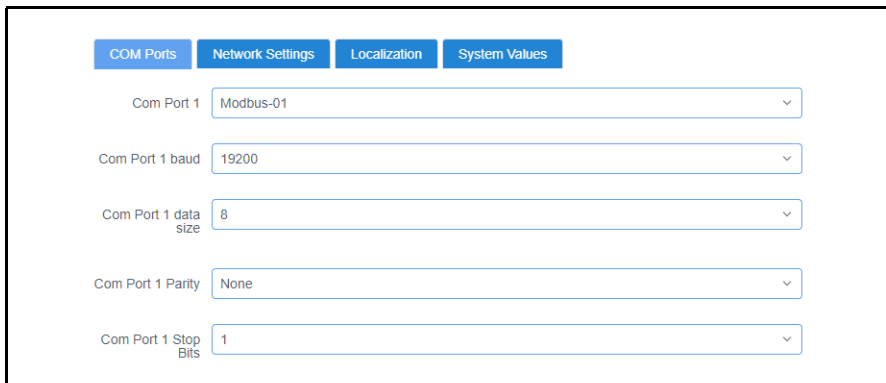



Figure 4-9 - Set Com Port Parameters

4.4.3. Adding the Touchscreen Thermostat Application in Site Supervisor

1. Click the **Control Inventory** icon (the box) .
2. Expand the **HVAC** category and go to the **Add Control** drop-down list and select **Touch T-Stat**.

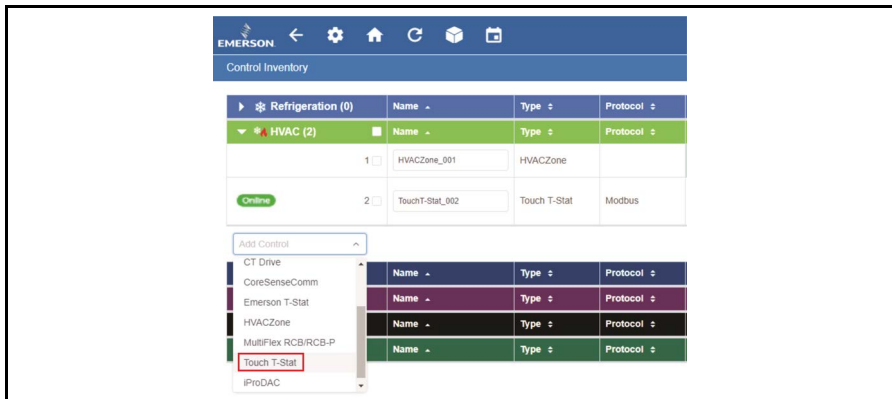

Figure 4-10 - Add Controls



IMPORTANT! Ensure the system configuration is selected correctly **PRIOR** to commissioning the device on the E2 or Site Supervisor/E3. Changing the system configuration after commissioning will result in some parameters not being able to be properly read or written. In this case the E2 or Site Supervisor/E3 application will need to be deleted and then recreated.

4.4.4. Installing and Commissioning the Touchscreen Thermostat

1. Click the **Port ID** drop-down list to select Modbus assigned to the Com Port selected in **Section 4.4.3**.
2. Click the **Address** drop-down list to select the Modbus Address (default address is **1**).
3. Click the **Association** drop-down list to select the **HVACZone** to associate with the thermostat.

4. Click **Update** to save settings.

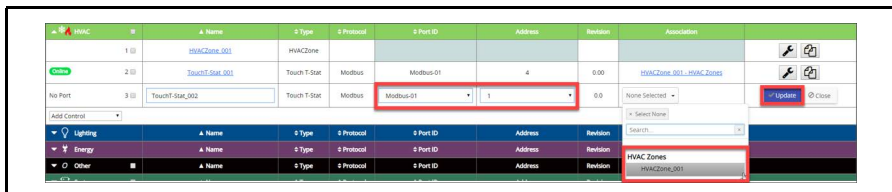

Figure 4-11 - Setting Up the Thermostat Update

5. Wait a few seconds and the device should appear **Online**.

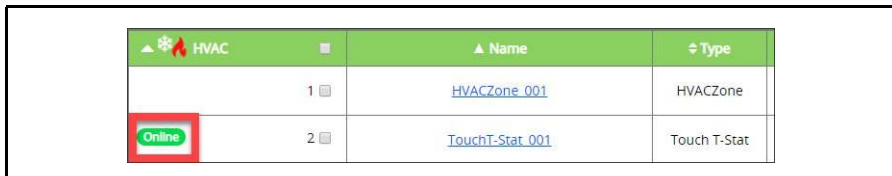

Figure 4-12 - Device is Online

5 Troubleshooting

In the unlikely occurrence of a problem with the thermostat, please try the following suggestions. Most problems can usually be corrected promptly and easily.

Problems	Suggestions
Display is blank, corrupted or shows “E01” or “- -“	<ul style="list-style-type: none">• Make sure the operating conditions are within the specifications (temperature range and humidity range).• Open the thermostat enclosure as per <i>Section 2.3., Thermostat Installation</i> and wait 30 seconds prior to closing the enclosure.• Check the circuit breaker for 24VAC and reset if necessary.• Check the power switch at HVAC system and make sure it is ON.
Display shows “Lo”	<ul style="list-style-type: none">• Check that the room temperature is not under 0°C or 32°F.
Display shows “HI”	<ul style="list-style-type: none">• Check that the room temperature is not above 50°C or 122°F.
Heating or cooling system does not respond	<ul style="list-style-type: none">• Set Thermostat Mode to HEAT, and make sure the HEAT temperature setpoint is higher than the current room temperature.• Set Thermostat Mode to COOL, and make sure the COOL temperature setpoint is lower than the current room temperature.• Open the thermostat enclosure as per <i>Section 2.3., Thermostat Installation</i> and wait 30 seconds prior to closing the enclosure.• Check circuit breaker for 24VAC and reset if necessary.• Check the power switch at HVAC system and make sure it is ON.• Check that Rc terminal is properly connected to R terminal with shorting jumper wire.
Modbus network does not respond	<ul style="list-style-type: none">• Open the thermostat enclosure as per <i>Section 2.3., Thermostat Installation</i> and wait 30 seconds prior to closing the enclosure.• Check circuit breaker for 24VAC and reset if necessary.• Check the power switch at HVAC system and make sure it is ON.• Make sure that wirings are intact and properly connected to the terminal blocks.• Make sure that A- and B+ signal are properly connected and not inverted.• Check the configuration of DIP switches to match your network (PU+, EOL and PD-).

Table 5-1 - Thermostat Troubleshooting

If a problem is still present after the above suggestions, please contact Emerson Technical Support 770-425-2724 or email ColdChain.TechnicalServices@Emerson.com.

6 Regulatory Information

- **Non-safety Declaration:** The thermostat does not exhibit any safety risk to the user if the usage guidelines are followed. No safety function is present in the thermostat.
- **Power Supply Guidelines:** The thermostat must be power supplied by an NEC (National Electrical Code) Class II limited power 24VAC transformer
- FCC Compliant to CFR47, Part 15, Subpart B, Class B
- Industry Canada (IC) Compliant to ICES-003, Issue 6

This device complies with Part 15 of the FCC Rules. Operation is subject to the following two conditions:

1. This device may not cause harmful interference, and
2. This device must accept any interference received, including interference that may cause undesired operation



CAUTION! Any changes or modifications not approved by Emerson can void the user's authority to operate the equipment.

NOTE: This equipment has been tested and found to comply with the limits for a Class B digital device, pursuant to part 15 of the FCC Rules. These limits are designed to provide reasonable protection against harmful interference in a residential installation. This equipment generates, uses and can radiate radio frequency energy and, if not installed and used in accordance with the instructions, may cause harmful interference to radio communications. However, there is no guarantee that interference will not occur in a particular installation. If this equipment does cause harmful interference to radio or television reception, which can be determined by turning the equipment off and on, the user is encouraged to try to correct the interference by one or more of the following measures:

- Reorient or relocate the receiving antenna.
- Increase the separation between the equipment and receiver.
- Connect the equipment into an outlet on a circuit different from that to which the receiver is connected.
- Consult the dealer or an experienced radio/TV technician for help.

This Class B digital apparatus meets all the requirements of the Canadian Interference-Causing Equipment regulations.

 **WARNING****CALIFORNIA PROPOSITION 65**

This product can expose you to chemicals including lead, which are known by the State of California to cause cancer and birth defects or other reproductive harm.

For more information, go to www.P65Warnings.ca.gov

Failure to follow these instructions can result in birth defects or other reproductive harm.



For Technical Support call 833-409-7505 or email ColdChain.TechnicalServices@Emerson.com

The contents of this publication are presented for informational purposes only and they are not to be construed as warranties or guarantees, express or implied, regarding the products or services described herein or their use or applicability. Emerson reserves the right to modify the designs or specifications of such products at any time without notice. Responsibility for proper selection, use and maintenance of any product remains solely with the purchaser and end-user. ©2022 Emerson is a trademark of Emerson Electric Co.